

BOSSINI

& PROFESSIONAL 19/20





**BOSSINI ESPAÑA S.L.
SOLO PROFESIONAL S.L.**

P. I. Sta. Maria Park - F. Maresma, 2

08460 Palautordera (Barcelona)

Telf. 902 44 77 44 / 93 848 33 29

Fax 902 44 77 88

 637 01 30 29

info@bossini-cristina.com

www.bossini-cristina.com





ROCIADORES



CONJUNTOS + DUCHAS



KITS WC + BIDÉ



COMPLEMENTOS DUCHA



DESAGÜES + SIFONES LAVABO



DESAGÜES DUCHA + BAÑERA



PLATOS DE DUCHA OBRA



FLUIDMASTER



COLECTIVIDADES:
GRIFERÍA ELECTRÓNICA + TEMPORIZADA



PROFESIONAL



CROMOTERAPIA



SYNCRONIA



DREAM



MANHATTAN



RENOVATION



ROCIADORES



BRAZOS DUCHA



A TECHO



A PARED



CONJUNTOS DUCHA



MANGOS DUCHA



BARRA DUCHA



CONJUNTOS DUPLEX



FLEXOS



KITS BIDÉ 2 AGUAS



KITS BIDÉ 1 AGUA



KITS WC



MANGOS BIDÉ



IDEA DUCHA



COLUMNA PISCINA 2 AGUAS



COLUMNA PISCINA 1 AGUA



DUCHITAS LATERALES



SOPORTES DUCHA



AHORRO DE AGUA



COMPLEMENTOS



SIFONES LATÓN



SIFONES PP



DESAGÜES LAVABO CLICKER



DESAGÜES LAVABO TWIST



DESAGÜES LAVABO UP&DOWN



DESAGÜES LAVABO



DESAGÜES FREGADERO



REBOSADERO LAVABO



COMPLEMENTOS



VÁLVULA PLATO DUCHA OMP



VÁLVULA PLATO DUCHA SILFRA



DESAGÜES BAÑERA



SUMIDEROS



REGISTROS BAÑERA



TEJIDO TÉCNICO



TEJIDO PVC



BAÑERA DE OBRA



COMPLEMENTOS



CISTERNAS EMPOTRADAS



PLACAS



FLOTADORES



DESCARGAS



COMPLEMENTOS



KITS BIDÉ



CLINIC



GRIFERÍA ELECTRÓNICA



GRIFERÍA TEMPORIZADA



EXPOSITORES



PROFESIONAL

ROCIADORES

CONJUNTOS+DUCHAS

KITS WC + BIDÉ

COMPLEMENTOS DUCHA

LAVABO: SIFONES Y DESAGÜES

DUCHA/BAÑERA: DESAGÜES Y SUMIDEROS

PLATOS DE DUCHA OBRA

FLUIDMASTER

COLECTIVIDADES

PROFESIONAL

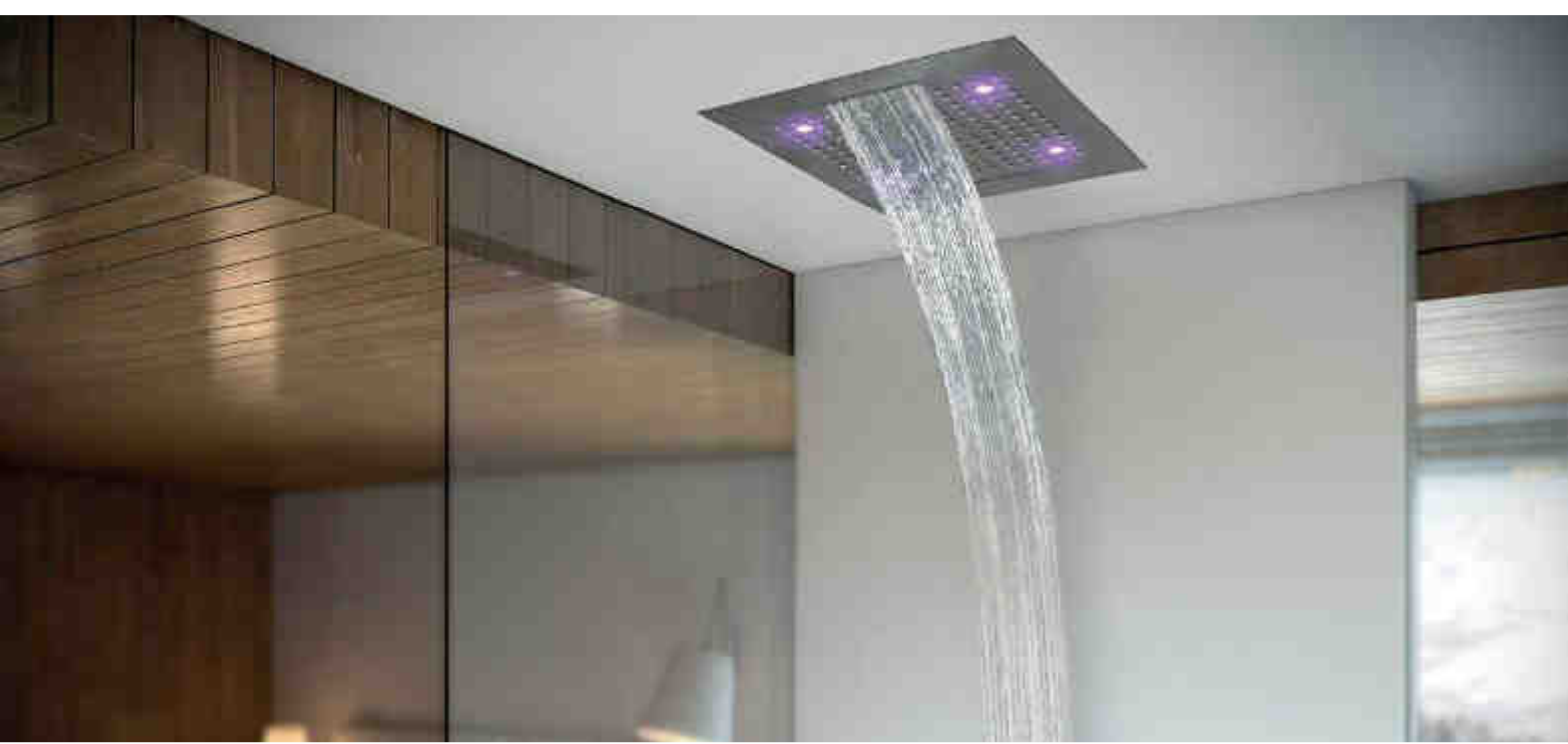





100591

Rociador SYNCRO-RAIN/3.

Cromo (51): 1.440,00

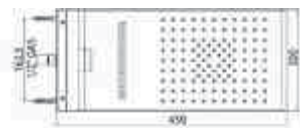

H38908

DREAM 4 funciones (4 entradas de agua).
Consumo mínimo 16 l/min.

Cromo (51): 3.663,00

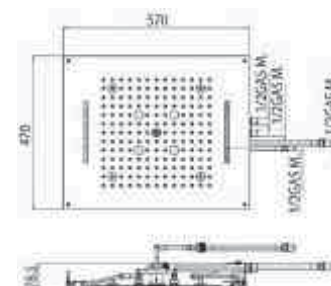

100590

Rociador SYNCRO-NEB/3.

Cromo (51): 1.440,00

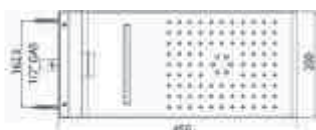

H38909

DREAM 4 funciones (4 entradas de agua).
Consumo mínimo 16 l/min.

Cromo (51): 3.342,00

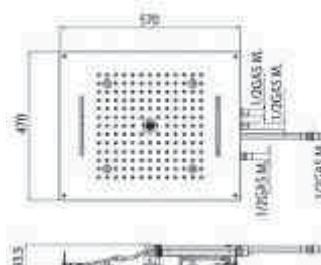

100592

Rociador SYNCRO-RAIN
RENOVATION/2.

Cromo (51): 1.453,00

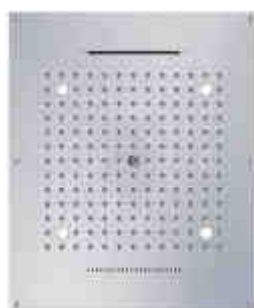
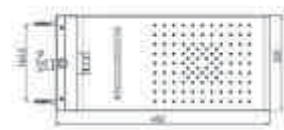

H38907

DREAM 3 funciones (3 entradas de agua).
Consumo mínimo 16 l/min.

Cromo (51): 3.056,00

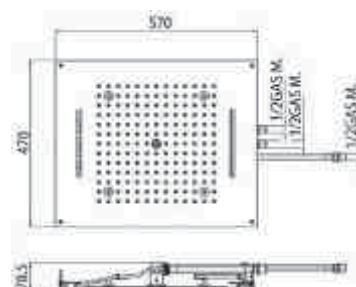



H38905 DREAM 2 funciones (2 entradas de agua). Consumo mínimo 16 l/min.

Cromo (51): 2.731,00

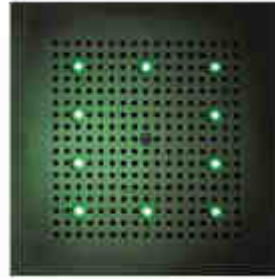
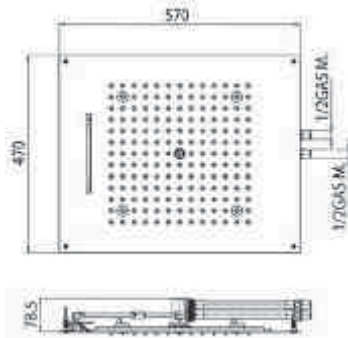

H37456 DREAM CUBE. Consumo mínimo 16 l/min.

Cromo (51): 3.537,00

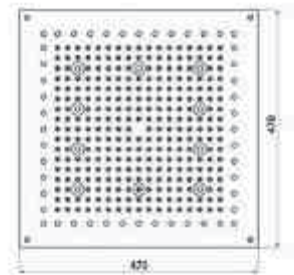
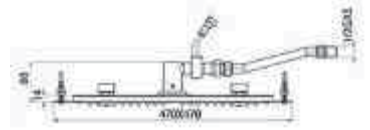

H38906 DREAM 2 funciones (2 entradas de agua). Consumo mínimo 16 l/min.

Cromo (51): 2.731,00

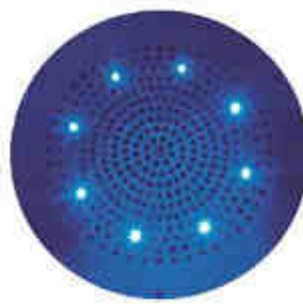
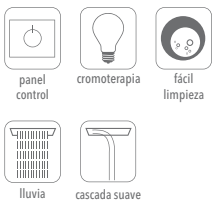
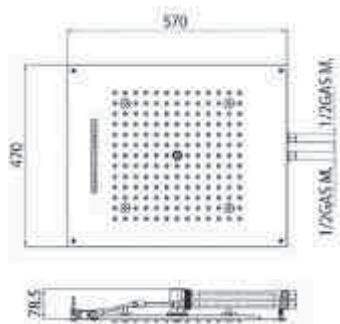

H37457 DREAM OKI. Consumo mínimo 16 l/min.

Cromo (51): 3.377,00

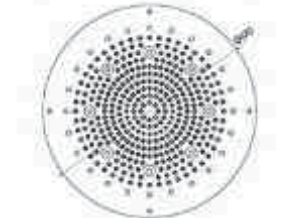
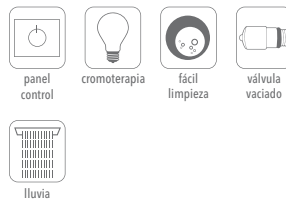

H37455 DREAM RECTANGULAR. Consumo mínimo 16 l/min.

Cromo (51): 3.930,00

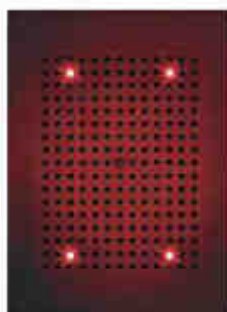

H37450 DREAM RECTANGULAR. Consumo mínimo 14 l/min.

Cromo (51): 3.065,00

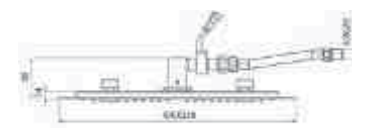

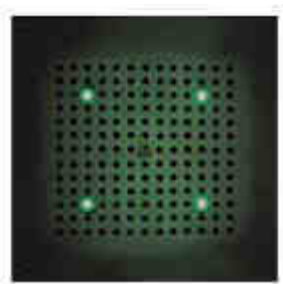

H37451 DREAM CUBE. Consumo mínimo 14 l/min.

Cromo (51): 2.536,00

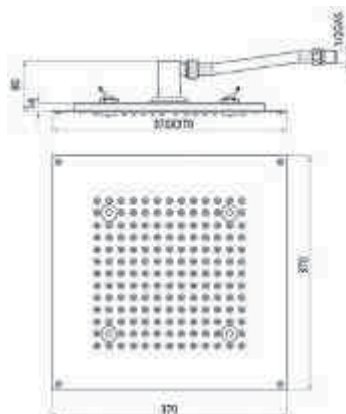

I01723 CUBE.

Cromo (51): 1.591,00

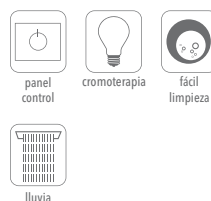
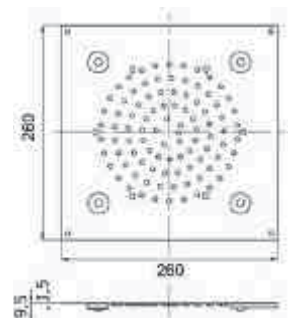

H37452 DREAM OKI. Consumo mínimo 14 l/min.

Cromo (51): 2.974,00

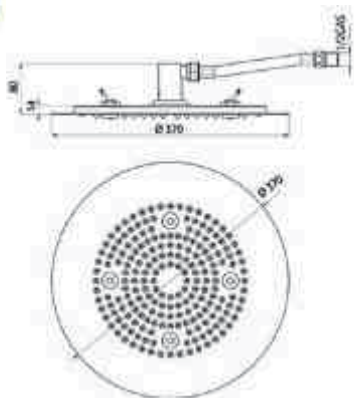

I01724 OKI.

Cromo (51): 1.591,00

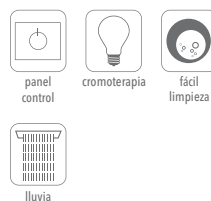
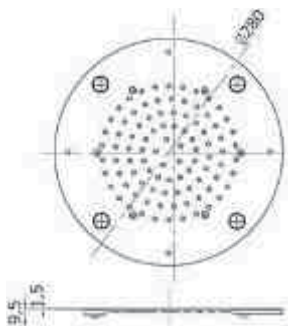

H38661 DREAM RECTANGULAR NEBULIZADO. (2 entradas de agua). Consumo mínimo 16 l/min.

Cromo (51): 4.269,00

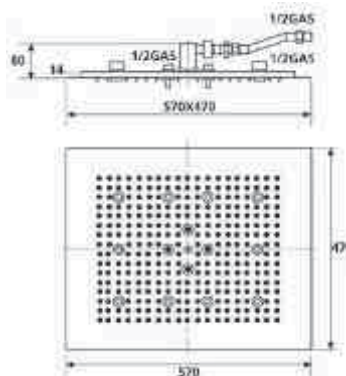

I00724 OKI LIGHT. La luz se enciende con interruptor independiente.

Cromo (51): 673,00

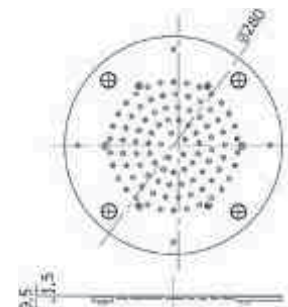



H37395

DREAM RECTANGULAR LIGHT.
Consumo mínimo 16 l/min.

- Cromo Led Blanco (0): 2.718,00
- Cromo Led Rojo (1): 2.718,00
- Cromo Led Azul (2): 2.718,00
- Cromo Led Verde (3): 2.718,00
- Cromo Led Naranja (4): 2.718,00

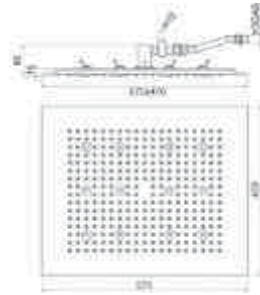

NOTA: Si en el pedido no se especifica color de LEDS, será entregado el estándar, entendiéndose éste como la combinación Cromo Led Blanco.



H37454

DREAM OKI LIGHT.
Consumo mínimo 16 l/min.

- Cromo Led Blanco (0): 2.312,00
- Cromo Led Rojo (1): 2.312,00
- Cromo Led Azul (2): 2.312,00
- Cromo Led Verde (3): 2.312,00
- Cromo Led Naranja (4): 2.312,00

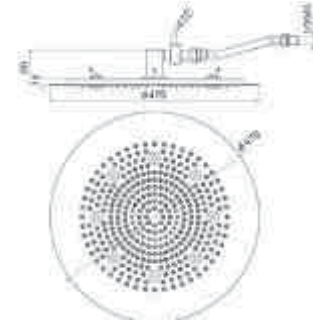

NOTA: Si en el pedido no se especifica color de LEDS, será entregado el estándar, entendiéndose éste como la combinación Cromo Led Blanco.



H37453

DREAM CUBE LIGHT.
Consumo mínimo 16 l/min.

- Cromo Led Blanco (0): 2.490,00
- Cromo Led Rojo (1): 2.490,00
- Cromo Led Azul (2): 2.490,00
- Cromo Led Verde (3): 2.490,00
- Cromo Led Naranja (4): 2.490,00

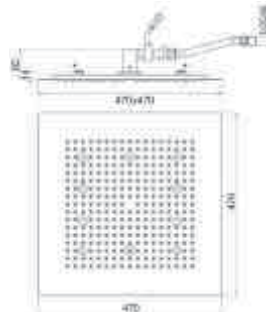

NOTA: Si en el pedido no se especifica color de LEDS, será entregado el estándar, entendiéndose éste como la combinación Cromo Led Blanco.



H37398

DREAM OKI LIGHT.
Consumo mínimo 16 l/min.

- Cromo Led Blanco (0): 1.568,00
- Cromo Led Rojo (1): 1.568,00
- Cromo Led Azul (2): 1.568,00
- Cromo Led Verde (3): 1.568,00
- Cromo Led Naranja (4): 1.568,00

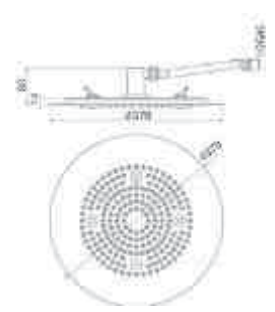

NOTA: Si en el pedido no se especifica color de LEDS, será entregado el estándar, entendiéndose éste como la combinación Cromo Led Blanco.



H37397

DREAM CUBE LIGHT.
Consumo mínimo 14 l/min.

- Cromo Led Blanco (0): 1.541,00
- Cromo Led Rojo (1): 1.541,00
- Cromo Led Azul (2): 1.541,00
- Cromo Led Verde (3): 1.541,00
- Cromo Led Naranja (4): 1.541,00

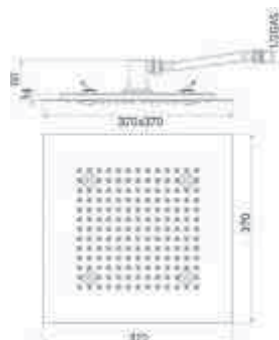

NOTA: Si en el pedido no se especifica color de LEDS, será entregado el estándar, entendiéndose éste como la combinación Cromo Led Blanco.



I00723

CUBE LIGHT. La luz se enciende con interruptor independiente.

Cromo (51): 673,00

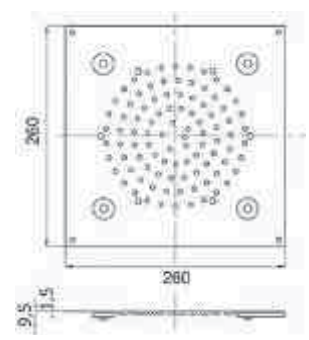



H38927

DREAM/3. (3 entradas de agua)
Consumo mínimo 16 l/min.

Cromo (51): 2.066,00
 Negro mate (13): 3.063,00

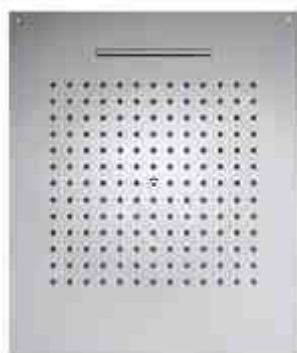
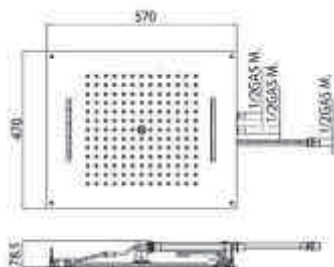

H38925

DREAM/2. (2 entradas de agua)
Consumo mínimo 16 l/min.

Cromo (51): 1.632,00

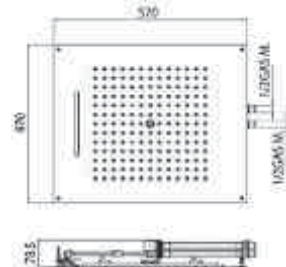

H38928

DREAM/4. (4 entradas de agua)
Consumo mínimo 16 l/min.

Cromo (51): 2.547,00

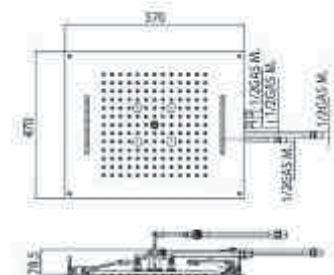

H38933

DREAM/2. (2 entradas de agua)
Consumo mínimo 16 l/min.

Cromo (51): 1.184,00

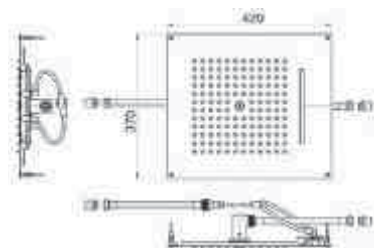

H38929

DREAM/4. (4 entradas de agua)
Consumo mínimo 16 l/min.

Cromo (51): 2.301,00

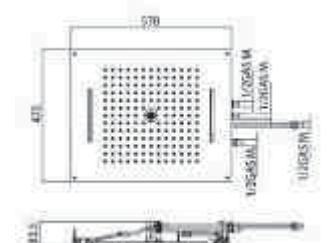

I00717

CUBE. Instalación a falso techo

Cromo (51): 284,00
 Negro mate (13): 516,00

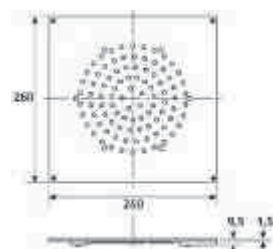



I00718

OKI. Instalación a falso techo

- Cromo (51): 284,00
- Negro mate (13): 527,00

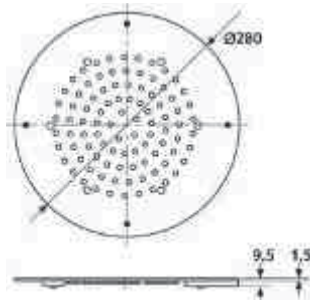

H35366

DREAM OVAL.
Consumo mínimo 14 l/min.

Cromo (51): 1.153,00

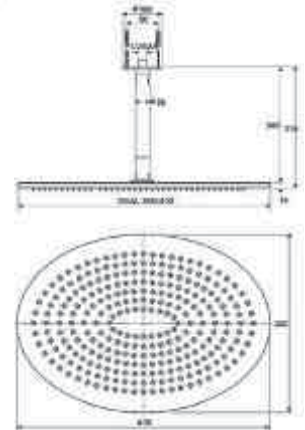

H35360

DREAM OKI.
Consumo mínimo 16 l/min.

Cromo (51): 1.615,00

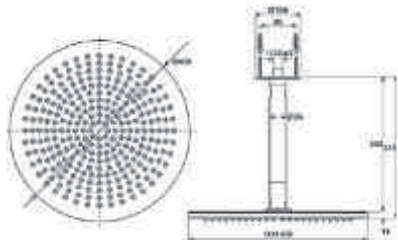

H35367

DREAM OVAL.
Consumo mínimo 16 l/min.

Cromo (51): 1.484,00

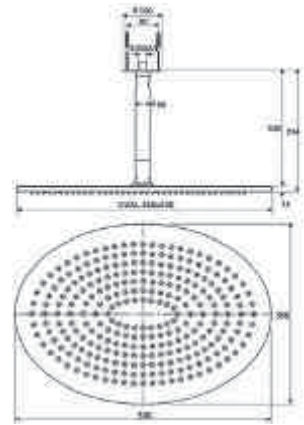

H35362

DREAM OKI.
Consumo mínimo 14 l/min.

Cromo (51): 1.108,00

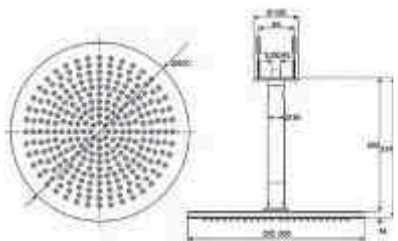

H35363

DREAM CUBE.
Consumo mínimo 16 l/min.

Cromo (51): 1.351,00

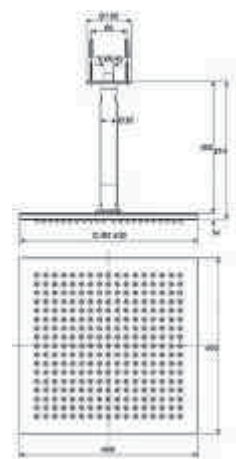



H35365
DREAM CUBE.
Consumo mínimo 14 l/min.

Cromo (51): 1.087,00

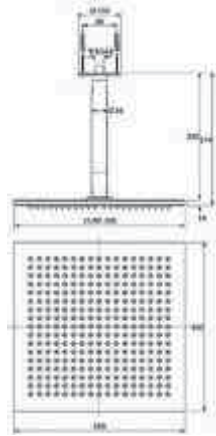

H38387
DREAM RECTANGULAR.
Consumo mínimo 14 l/min.

Cromo (51): 1.131,00

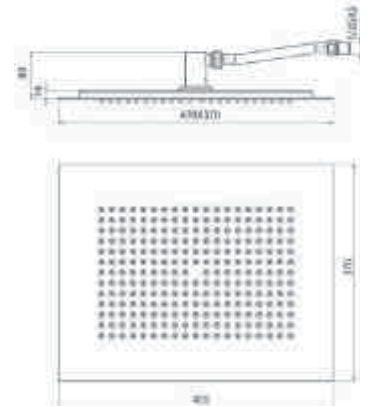

H35369
DREAM RECTANGULAR.
Consumo mínimo 16 l/min.

Cromo (51): 1.484,00

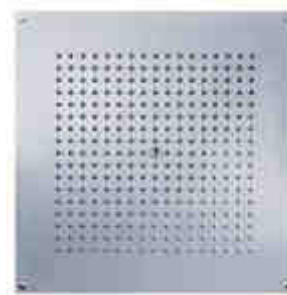
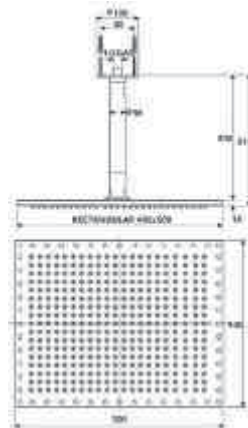

H38459
DREAM CUBE.
Consumo mínimo 16 l/min.

Cromo (51): 1.417,00

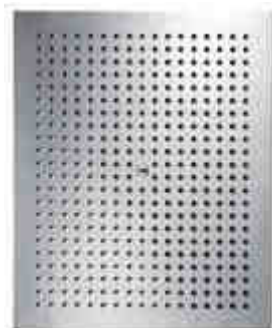
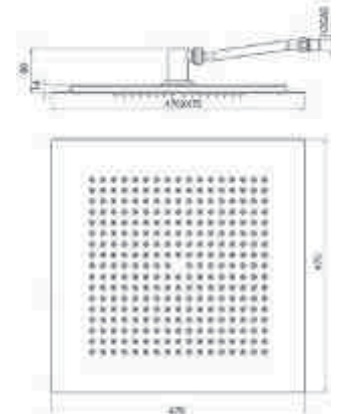

H35370
DREAM RECTANGULAR.
Consumo mínimo 14 l/min.

Cromo (51): 1.176,00

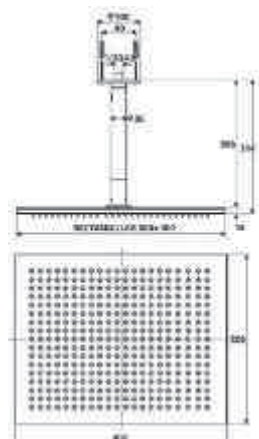

H38381
DREAM CUBE.
Consumo mínimo 14 l/min.

Cromo (51): 1.060,00

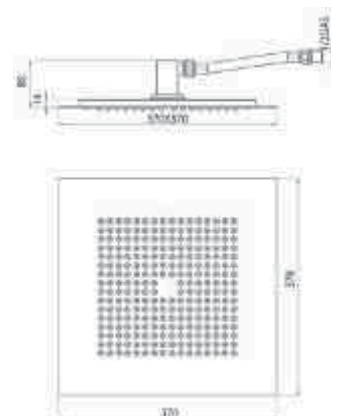

Dream / Manhattan

H38458

DREAM OKI.
Consumo mínimo 16 l/min.

Cromo (51): 1.389,00

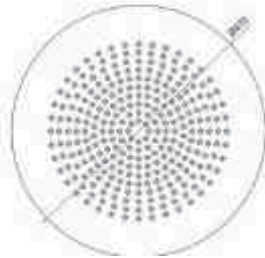
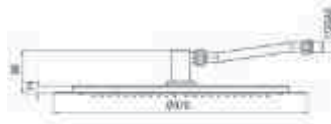

lluvia

 válvula
vaciado

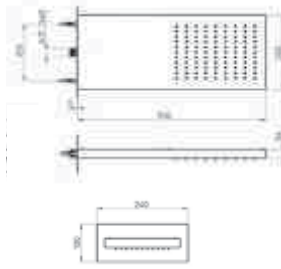
 fácil
limpieza

I00575

MANHATTAN 1. De acero inoxidable.

Cromo (51): 504,00
 Negro mate (13): 747,00



lluvia

H38380

DREAM OKI.
Consumo mínimo 14 l/min.

Cromo (51): 1.060,00

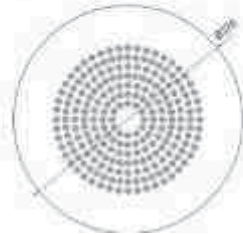
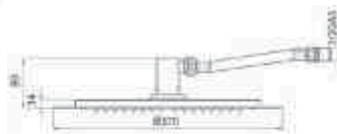

lluvia

 válvula
vaciado

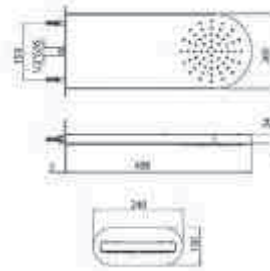
 fácil
limpieza

I00576

SIDNEY 1. De acero inoxidable.

Cromo (51): 855,00

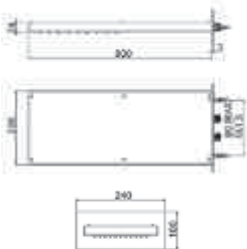

lluvia

I00570

MANHATTAN 2. De acero inoxidable.

Cromo (51): 567,00
 Negro mate (13): 823,00
 Inox (19): 846,00



lluvia

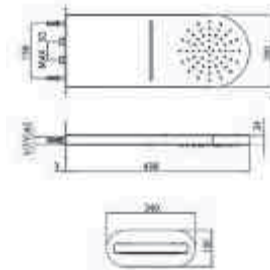

cascada

I00571

SIDNEY 2 con dos posiciones.
De acero inoxidable.

Cromo (51): 910,00



lluvia



cascada



L60002

Columna de ducha OKI RENOVATION
diam. 200 mm.

Cromo (51): 566,00

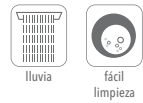
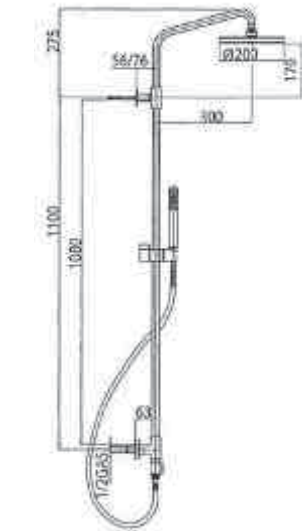

15 uds.



H89405C

Brazo de ducha giratorio RENOVATION
diam. 200 mm.

Cromo (51): 490,00

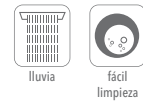
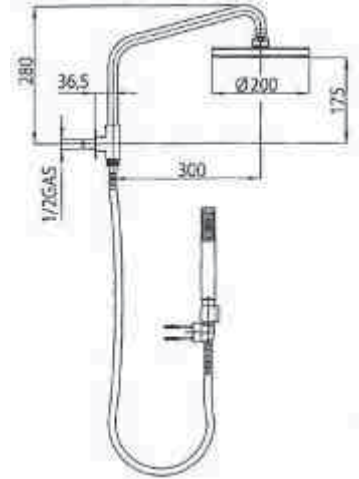

15 uds.



L60001

Columna de ducha OKI RENOVATION
diam. 200 mm.

Cromo (51): 566,00

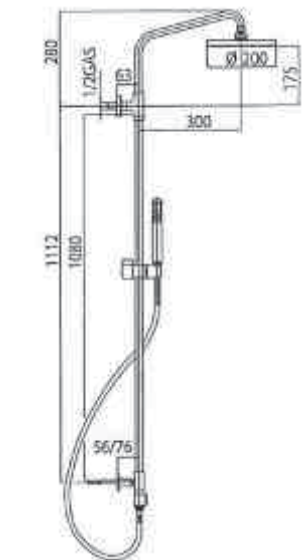

15 uds.



H93410G

Brazo de ducha RENOVATION diam.
250 mm.

Cromo (51): 539,00

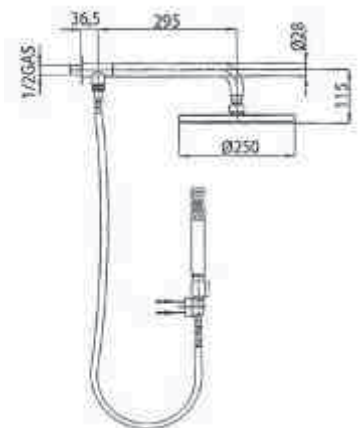

15 uds.

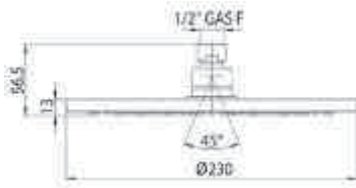

I00595

Rociador COSMO.

- Cromo (51): 174,00
- Negro mate (13): 306,00



15 uds.



I00597

Rociador COSMO.

- Cromo (51): 199,00



15 uds.

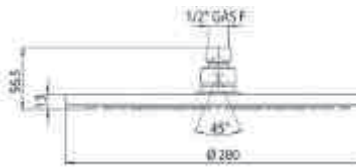

I00596

Rociador COSMO.

- Cromo (51): 230,00
- Negro mate (13): 406,00



15 uds.



I00598

Rociador COSMO.

- Cromo (51): 253,00

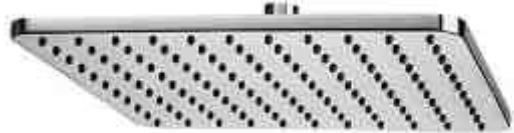

15 uds.

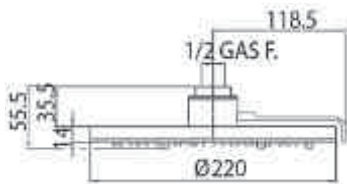

I00625

Rociador NEBULIZAIR/2.

- Cromo (51): 345,00



15 uds.

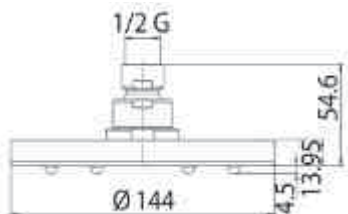

I00620

Rociador NEBULIZAIR.

- Cromo (51): 157,00



15 uds.



Rociadores

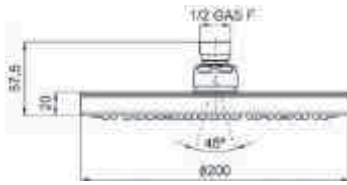

I00405

Rociador OKI latón.

- Cromo (51): 212,00
- Negro mate (13): 300,00
- Inox (19): 418,00
- Oro (52): 448,00
- ABS Cromo (51): 75,00

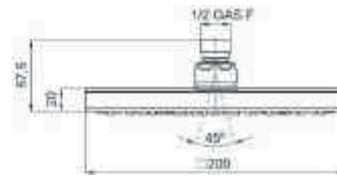

15 uds.



I00720

Rociador CUBE latón.

- Cromo (51): 256,00

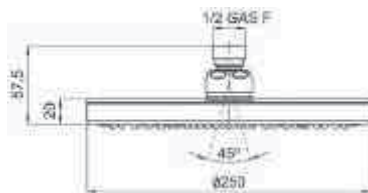

15 uds.



I00410

Rociador OKI latón.

- Cromo (51): 289,00

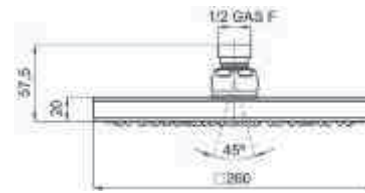

15 uds.



I00715

Rociador CUBE latón.

- Cromo (51): 296,00

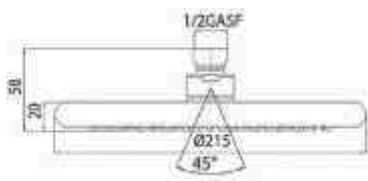

15 uds.

I00420

Rociador AGUA latón/ABS.

- Cromo (51): 117,00



15 uds.

I00171

Rociador QUADRO/3.

- Cromo (51): 103,00



15 uds.



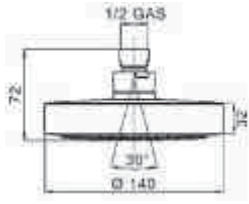

100166
Rociador DINAMIC latón.

Cromo (51): 54,00



15 uds.



100010
Rociador REGULINE/2 posiciones.

Cromo (51): 23,00

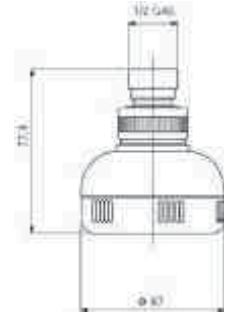

15 uds.

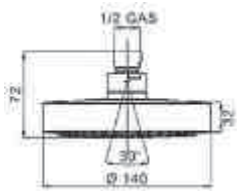

100169
Rociador DINAMIC/3.

Cromo (51): 69,00



15 uds.



100020
Rociador FRESH/3.

Cromo (51): 61,00

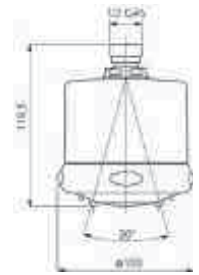

15 uds.



100065
Rociador latón.

Cromo (51): 24,00



30 uds.



100351
Rociador CYLINDRICO/5

Cromo (51): 34,00

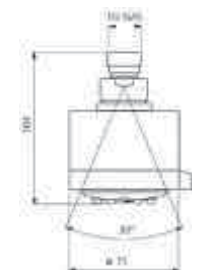

15 uds.





I00352
Rociador CYLINDRICO/1.

Cromo (51): 21,00



30 uds.



I00330
Rociador OVO-KARINA/3.

Cromo (51): 24,00



15 uds.



Brazos de ducha

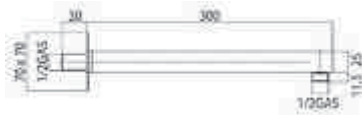

H69000
Brazo COSMO latón.

Cromo (51): 93,00



30 uds.

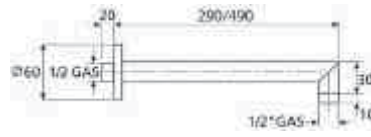

H70000
Brazo latón.

H70000G 300 mm.
Cromo (51): 35,00

H70000J 500 mm.
Cromo (51): 48,00



30 uds.



H60000
Brazo CUBE latón.

Cromo (51): 87,00



30 uds.



H19000
Brazo latón.

H19000D 200 mm.
Cromo (51): 18,00

H19000G 300 mm.
 Cromo (51): 23,00
 Negro mate (13): 50,00

H19000J 500 mm.
Cromo (51): 32,00



30 uds.

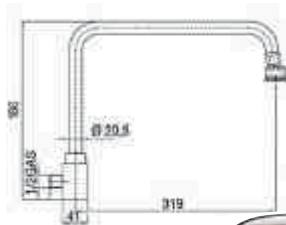

H55000
Brazo giratorio latón.

Cromo (51): 116,00



15 uds.



H61000
Brazo CUBE latón.

Cromo (51): 61,00

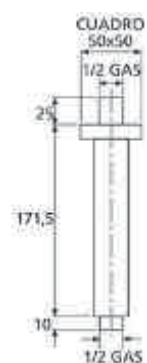

15 uds.



H31000

Brazo latón.

H31000D 200 mm.
Cromo (51): 17,00

H31000G 300 mm.
Cromo (51): 22,00

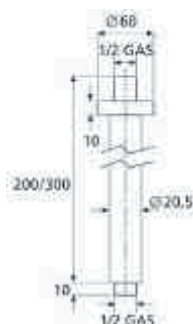

15 uds.

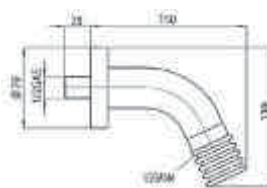

H41000

Brazo con goma cubre rótula.

Cromo (51): 53,00



15 uds.



H28000

Caño vertical a techo con aireador.

Cromo (51): 359,00

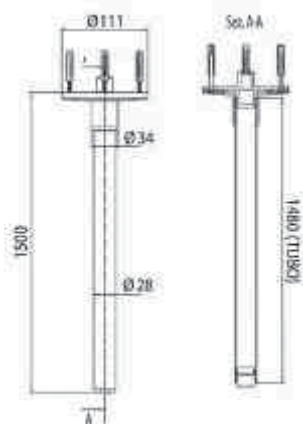

15 uds.

A techo

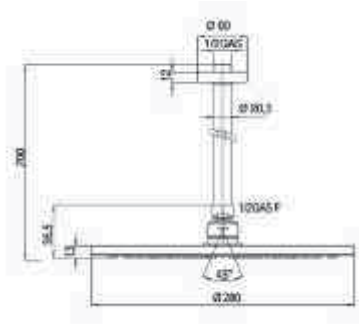

H31596

Brazo + rociador COSMO latón.

Cromo (51): 247,00

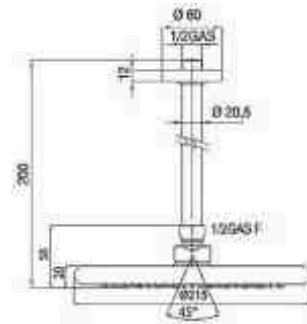

15 uds.



H31420

Brazo + rociador AGUA latón.

Cromo (51): 134,00

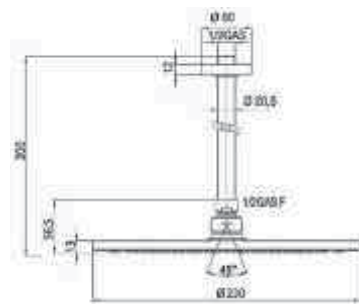

15 uds.



H31595

Brazo + rociador COSMO latón.

Cromo (51): 191,00

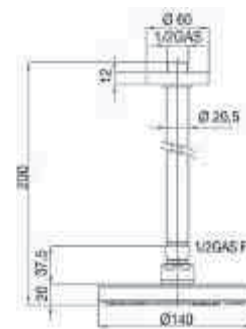

15 uds.



H31169

Brazo + rociador DINAMIC/3 latón.

Cromo (51): 86,00

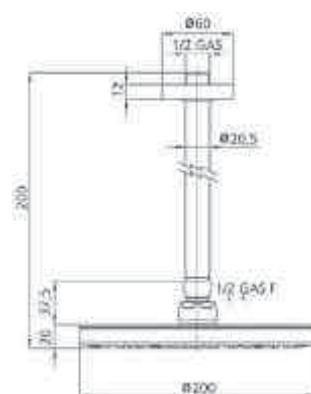

15 uds.



H31405

Brazo + rociador OKI latón.

Cromo (51): 229,00

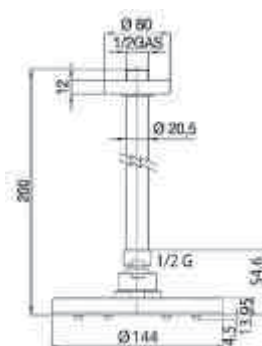

15 uds.

H31620

Brazo + rociador NEBULIZAIR.

Cromo (51): 174,00



15 uds.



H31598
 Brazo + rociador COSMO.
 Cromo (51): 270,00

Iluvia
 fácil limpieza

15 uds.

H61720
 Brazo + rociador CUBE latón.
 Cromo (51): 317,00

Iluvia
 fácil limpieza

15 uds.

H31597
 Brazo + rociador COSMO.
 Cromo (51): 216,00

Iluvia
 fácil limpieza

15 uds.

H61171
 Brazo + rociador QUADRO/3.
 Cromo (51): 164,00

Iluvia
 Iluvia suave
 Iluvia suave + Iluvia

50% ahorro
 fácil limpieza

15 uds.

H61715
 Brazo + rociador CUBE latón.
 Cromo (51): 357,00

Iluvia
 fácil limpieza

15 uds.

H31625
 Brazo + rociador NEBULIZAIR/2.
 Cromo (51): 362,00

Iluvia
 nebulizada
 50% ahorro
 fácil limpieza

15 uds.

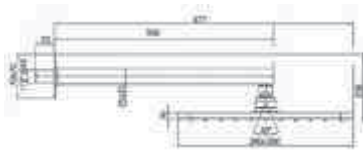

H69598

Brazo + rociador COSMO latón.

Cromo (51): 346,00



15 uds.



H70596

Brazo + rociador COSMO latón.

Cromo (51): 265,00



15 uds.



H69597

Brazo + rociador COSMO latón.

Cromo (51): 292,00



15 uds.



H70595

Brazo + rociador COSMO latón.

Cromo (51): 209,00



15 uds.

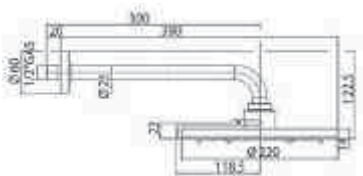

H19625

Brazo + rociador NEBULIZAIR/2 latón con difusor lluvia autolimpiante

Cromo (51): 368,00



15 uds.

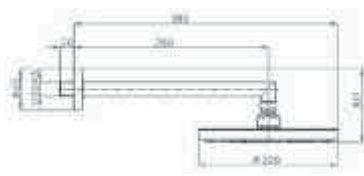

H70405 ABS

Brazo + rociador OKI ABS.

Cromo (51): 110,00



15 uds.



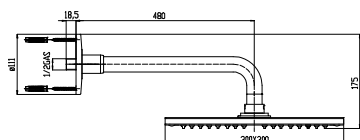

H75365
Brazo + rociador DREAM CUBE latón.
Cromo (51): 1.195,00



15 uds.



H60715
Brazo + rociador CUBE latón.
Cromo (51): 383,00



15 uds.

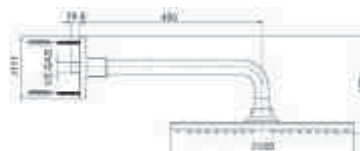
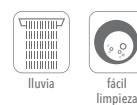

H75362
Brazo + rociador DREAM OKI latón.
Cromo (51): 1.195,00



15 uds.

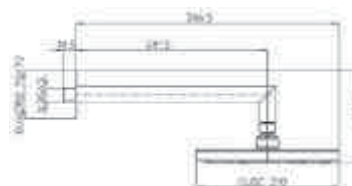

H60720
Brazo + rociador CUBE latón.
Cromo (51): 343,00



15 uds.

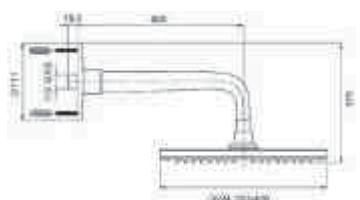

H75366
Brazo + rociador DREAM OVAL latón.
Cromo (51): 1.280,00



15 uds.



H70715
Brazo + rociador CUBE.
Cromo (51): 331,00



15 uds.



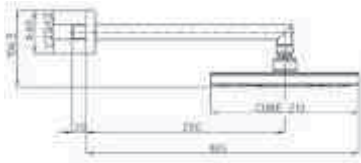

H70720
Brazo + rociador CUBE latón.

Cromo (51): 291,00



15 uds.

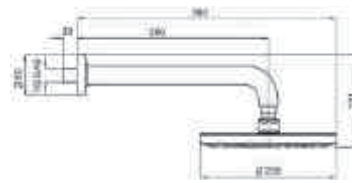

H19410
Brazo + rociador OKI latón.

Cromo (51): 312,00



15 uds.



H70410
Brazo + rociador OKI latón.

Cromo (51): 324,00



15 uds.

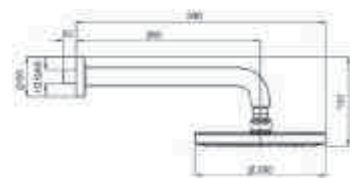

H19405
Brazo + rociador OKI latón.

Cromo (51): 235,00



15 uds.



H70405
Brazo + rociador OKI latón.

Cromo (51): 247,00



15 uds.



H19420
Brazo + rociador AGUA latón.

Cromo (51): 140,00



15 uds.



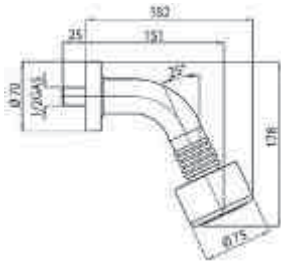

H41351
Brazo + rociador CYLINDRICO/5.

Cromo (51): 87,00



15 uds.

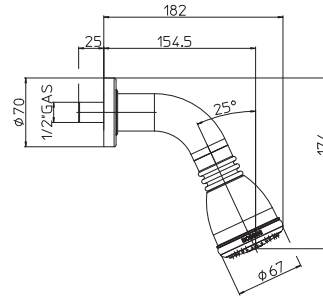

H41330
Brazo + rociador OVO-KARINA/3.

Cromo (51): 77,00



15 uds.

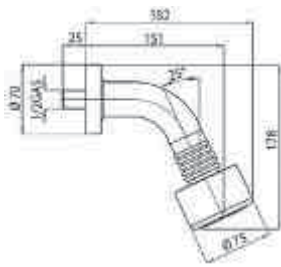

H41352
Brazo + rociador CYLINDRICO/1.

Cromo (51): 74,00



15 uds.

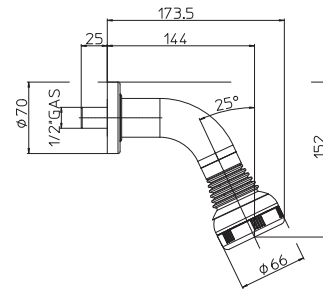

H41010
Brazo + rociador REGULINE/2.

Cromo (51): 76,00



15 uds.

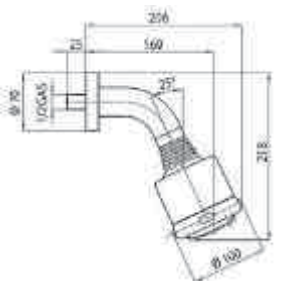

H41020
Brazo + rociador FRESH/3.

Cromo (51): 114,00



15 uds.



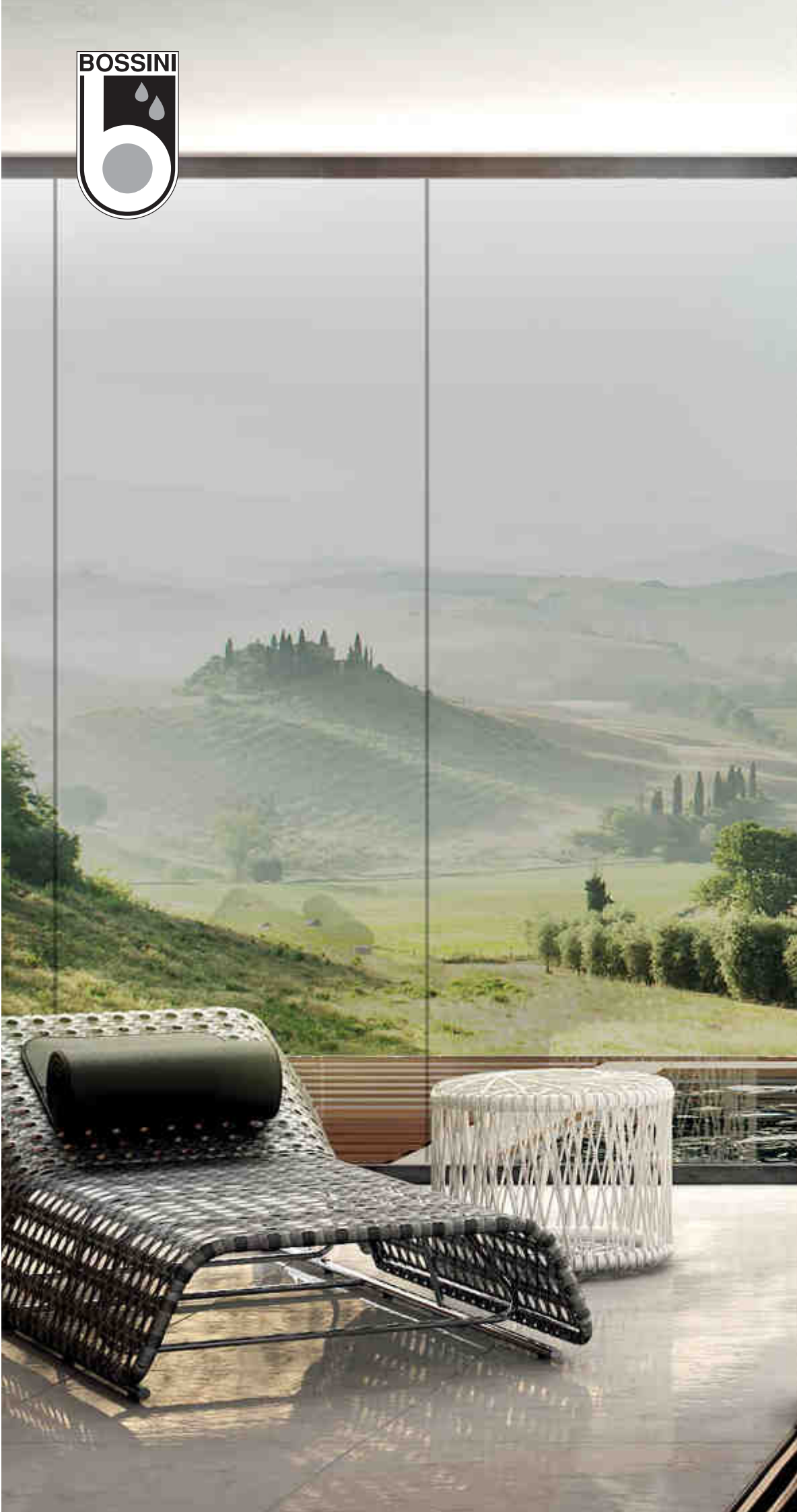

Barra deslizante SYNCRONIA + mango de ducha + flexo 175 cms. doble grapado.



DD10800

Conjunto ducha SYNCRONIA/6.

Cromo (51): 528,00



DD10805

Conjunto ducha SYNCRONIA/2.

Cromo (51): 481,00

Barra deslizante CHARLESTON + mango de ducha + flexo 175 cms. doble grapado.



030586

Conjunto ducha ROMAN/5.



Cromo (51):	246,00
Bronce (92):	419,00
Plata (90):	431,00
Oro (52):	503,00

030580

Conjunto ducha CHARLESTON.



Cromo (51):	223,00
Bronce (92):	374,00
Plata (90):	386,00
Oro (52):	502,00
Niquel (85):	370,00
Cromo/Oro (39):	301,00

030750

Conjunto ducha LIBERTY.



Cromo (51):	250,00
-------------	--------

Barra deslizante SLIM + mango de ducha
+ flexo 175 cms. CROMOLUX.



400250

Conjunto ducha ZEN.

- Cromo (51): 169,00
- Negro mate (13): 273,00
- Blanco mate (24): 273,00
- Inox (19): 398,00



400252

Conjunto ducha SLIM.

- Cromo (51): 182,00



400255

Conjunto ducha CUBE.

- Cromo (51): 186,00



400260

Conjunto ducha OVAL.

- Cromo (51): 182,00

Barra deslizando SLIM con toma de agua + mango ducha + flexo 175 cms. doble grapado.



15 uds.



410169
Conjunto ducha MIXA/3.

Cromo (51):	221,00
Negro mate (13):	368,00
Blanco mate (24):	264,00



410250
Conjunto ducha ZEN.

Cromo (51):	181,00
Negro mate (13):	316,00
Blanco mate (24):	353,00
Inox (19):	409,00

Barra deslizante CUBE + mango ducha
+ flexo 175 cms. doble grapado.

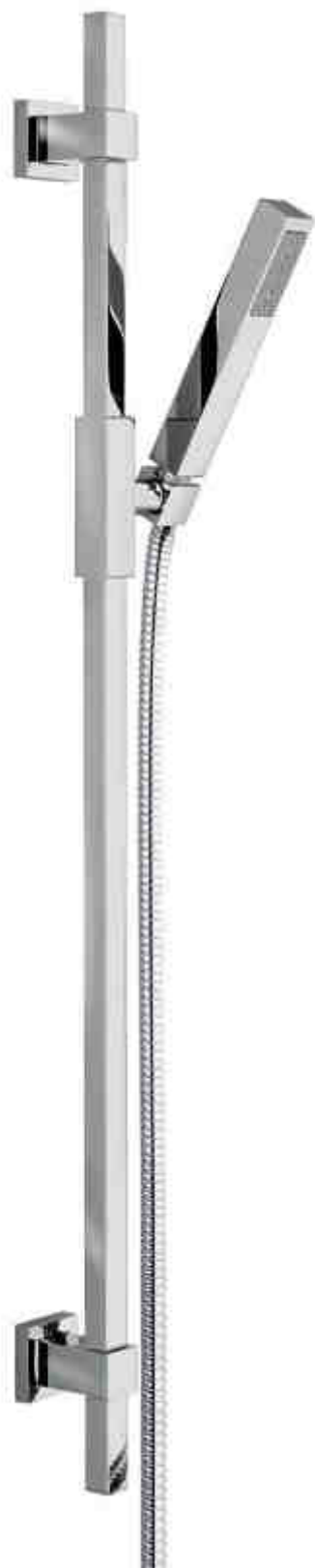

910255

Conjunto ducha CUBE.

Cromo (51):

238,00



910270

Conjunto ducha FLAT.

Cromo (51):

252,00



910177

Conjunto ducha AGUA LIFE/2.

Cromo (51):

240,00

Barra deslizante TRIO-DROP + mango ducha + flexo 175 cms. doble grapado.



010043

Conjunto ducha FRESH/3.

Cromo (51): 202,00
 Blanco mate (24): 214,00



010800

Conjunto ducha SINCRONIA/6.

Cromo (51): 234,00



010805

Conjunto ducha SINCRONIA/2.

Cromo (51): 187,00

Barra deslizante ALOHA + mango de ducha + flexo 175 cms. CROMOLUX.



15 uds.



740169

Conjunto ducha MIXA/3.

Cromo (51):	155,00
Negro mate (13):	250,00
Blanco mate (24):	235,00



740168

Conjunto ducha MIXA/3.

Cromo (51):	156,00
-------------	--------



740805

Conjunto ducha SINCRONIA/2.

Cromo (51):	129,00
-------------	--------

Barra deslizante AGUA PROJECT + mango de ducha + flexo 175 cms. CROMOLUX.



15 uds.



A500160

Conjunto ducha CYLINDRICA/3.

Cromo (51): 94,00



A500802

Conjunto ducha SINCRONIA/1.

Cromo (51): 90,00



A500168

Conjunto ducha MIXA/3.

Cromo (51): 126,00



A500169

Conjunto ducha MIXA/3.

Cromo (51): 125,00
 Negro mate (13): 204,00
 Blanco mate (24): 189,00

Barra deslizando TRISS + mango de ducha
+ flexo 175 cms. doble grapado.



070075

Conjunto ducha VITALITY/5.

Cromo (51): 92,00



070805

Conjunto ducha SINCRONIA/2.

Cromo (51): 95,00

Barra deslizante YUMA + mango de ducha + flexo 175 cms. CROMOLUX.



15 uds.



720802

Conjunto ducha SINCRONIA/1.

Cromo (51): 72,00



720167

Conjunto ducha DINAMICA.

Cromo (51): 97,00



720160

Conjunto ducha CYLINDRICA/3.

Cromo (51): 75,00

Barra deslizando RENOVATION + mango de ducha + flexo 175 cms. CROMOLUX.



DE6805

Conjunto ducha SINCRONIA 2.

Cromo (51): 105,00



DE6169

Conjunto ducha MIXA/3.

Cromo (51): 131,00



DE6168

Conjunto ducha MIXA/3.

Cromo (51): 132,00



DE6802

Conjunto ducha SINCRONIA/1.

Cromo (51): 96,00



DE6160

Conjunto ducha CYLINDRICA/3.

Cromo (51): 100,00



B00800

Ducha SINCRONIA/6 con 6 posiciones.

Cromo (51): 81,00

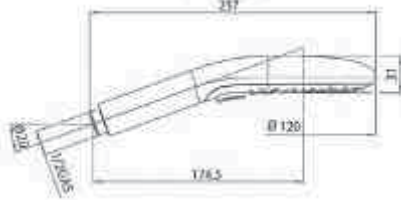

15 uds.



B00168

Ducha MIXA/3 con 3 posiciones FIT AIR.

Cromo (51): 60,00

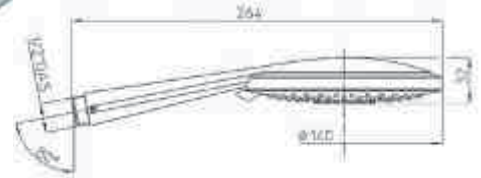

15 uds.



B00805

Ducha SINCRONIA/2 con 3 posiciones.

Cromo (51): 33,00

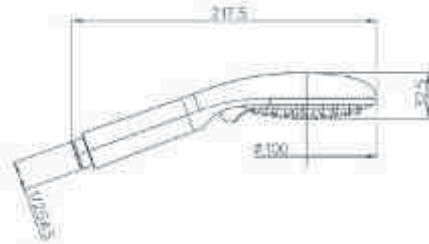

15 uds.



B00169

Ducha MIXA/3 con 3 posiciones FIT AIR.

Cromo (51): 59,00
 Negro mate (13): 83,00
 Blanco mate (24): 68,00

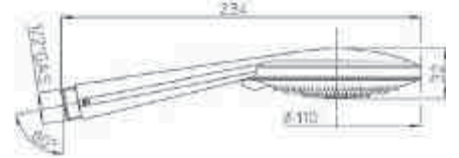

15 uds.



B00802

Ducha SINCRONIA/1.

Cromo (51): 24,00

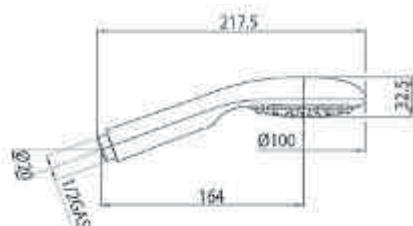

15 uds.



B00177

Ducha AGUA LIFE con 2 posiciones.

Cromo (51): 39,00

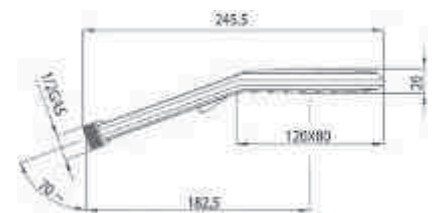

25 uds.





B00586
 Ducha ROMAN/5 con 5 posiciones latón.

☐ Cromo (51):	70,00
☐ Bronce (92):	123,00
☐ Oro (52):	115,00

☐ 15 uds.

lluvia	masaje	vapor	lluvia + vapor	lluvia + masaje	fácil limpieza



B00043
 Ducha FRESH/3 con 3 posiciones.

☐ Cromo (51):	49,50
☐ Blanco (06):	58,00

☐ 15 uds.

lluvia	masaje	vapor	fácil limpieza

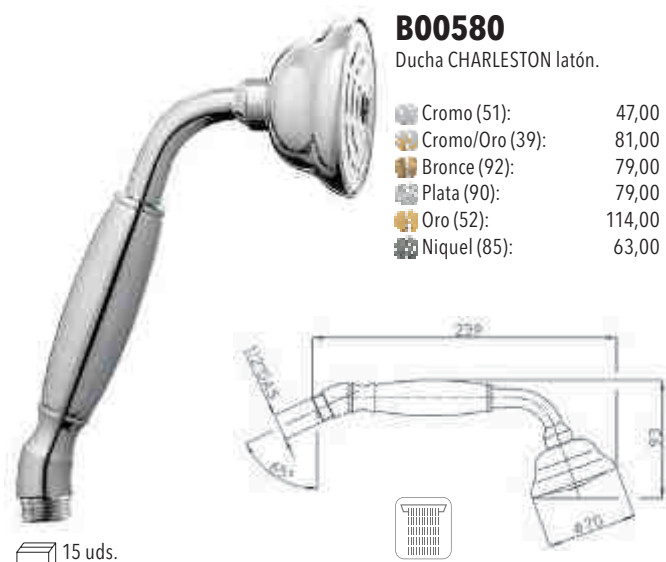

B00580
 Ducha CHARLESTON latón.

☐ Cromo (51):	47,00
☐ Cromo/Oro (39):	81,00
☐ Bronce (92):	79,00
☐ Plata (90):	79,00
☐ Oro (52):	114,00
☐ Niquel (85):	63,00

☐ 15 uds.

lluvia

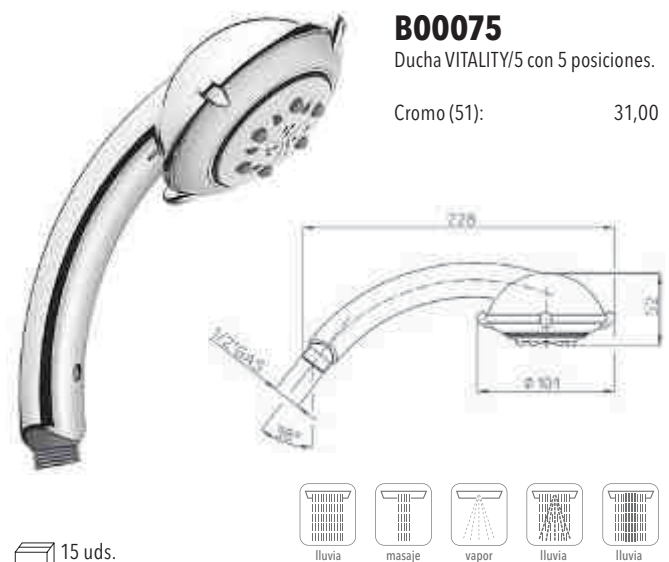

B00075
 Ducha VITALITY/5 con 5 posiciones.

Cromo (51):	31,00
-------------	-------

☐ 15 uds.

lluvia	masaje	vapor	lluvia + vapor	lluvia + masaje



B00750
 Ducha LIBERTY latón.

Cromo (51):	73,00
-------------	-------

☐ 15 uds.

lluvia	fácil limpieza



B00152
 Ducha DUETTO-NEB con 3 posiciones.

Cromo (51):	29,00
-------------	-------

☐ 25 uds.

lluvia	masaje	lluvia + masaje	fácil limpieza



B00161
Ducha CYLINDRICA.

Cromo (51): 17,00

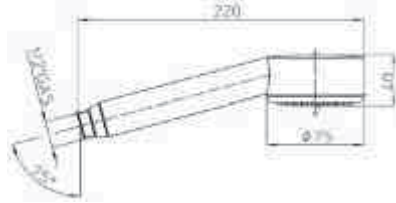

25 uds.



B00069
Ducha MIKI con 3 posiciones.

Cromo (51): 19,00
Blanco (06): 23,00

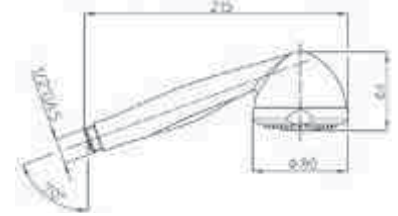

25 uds.



B00167
Ducha DINAMICA.

Cromo (51): 49,00

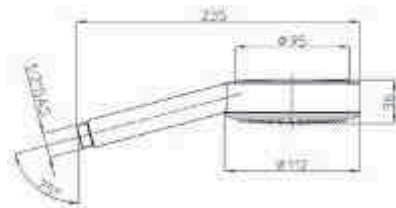

25 uds.



B00067
Ducha KARINA con 3 posiciones.

Cromo (51): 19,00
Blanco (06): 15,00

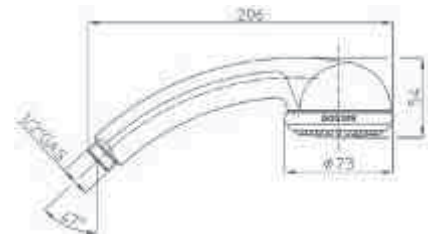

25 uds.



B00162
Ducha CYLINDRICA/5 con 5 posiciones.

Cromo (51): 32,00

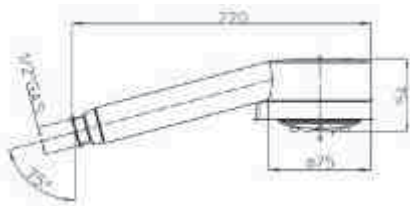

15 uds.



B00160
Ducha CYLINDRICA/3 con 3 posiciones.

Cromo (51): 28,00

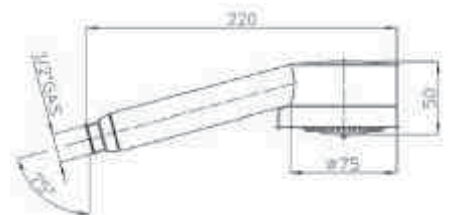

15 uds.





B00250

Ducha ZEN latón.

- Cromo (51): 19,00
- Cromo negro (72): 73,00
- Oro rosa (46): 77,00
- Oro rosa satinado (34): 84,00
- Negro mate (13): 31,00
- Blanco mate (24): 31,00
- Inox (19): 45,00



15 uds.



B00260

Ducha OVAL latón.

Cromo (51): 33,00



15 uds.



B00255

Ducha CUBE latón.

Cromo (51): 37,00



15 uds.



B00270

Ducha FLAT ONE.

Cromo (51): 51,00

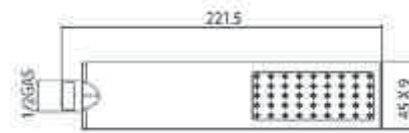

15 uds.



B00252

Ducha SLIM latón.

Cromo (51): 32,00



15 uds.



B00092

Ducha PETRA.

Cromo (51): 13,00
Blanco (06): 10,00

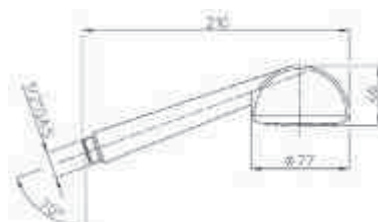

60 uds.





D91000

Barra deslizable CUBE latón.

Cromo (51): 181,00

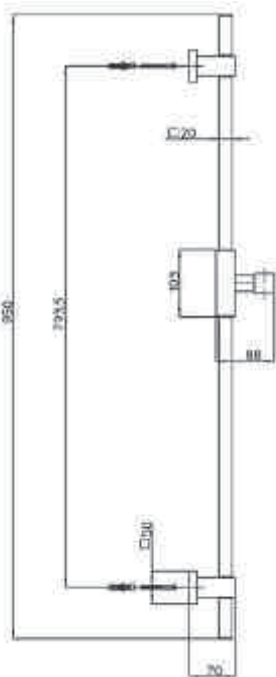

15 uds.



D01000

Barra deslizable TRIO-DROP latón.
Diam. 25 mm.

Cromo (51): 134,00
Blanco (06): 134,00
Oro (52): 230,00

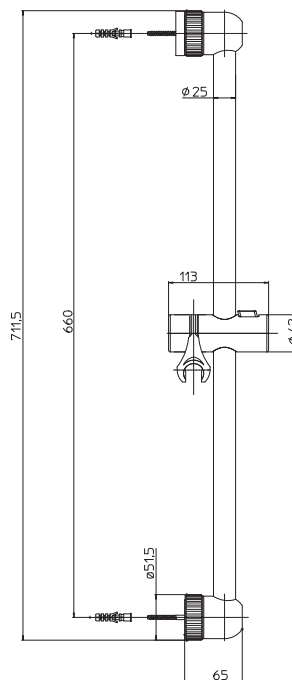

15 uds.



D74000

Barra deslizable ALOHA latón/ABS.
Diam. 25 mm.

Cromo (51): 84,00
Inox (19): 159,00
Negro mate (13): 145,00
Blanco mate (24): 145,00

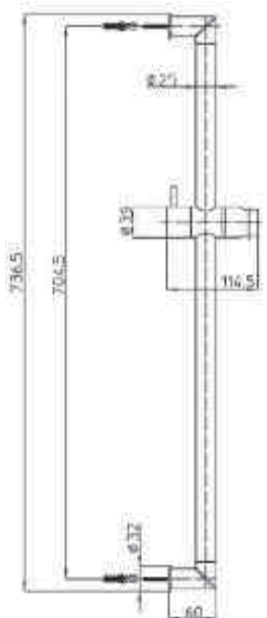

15 uds.



DA5000

Barra deslizable AGUA PROJECT
latón/ABS. Diam. 20 mm.

Cromo (51): 54,00
Negro mate (13): 99,00
Blanco mate (24): 99,00



15 uds.



D07000

Barra deslizante TRISS latón/ABS.
Diam. 25 mm.

Cromo (51): 42,00

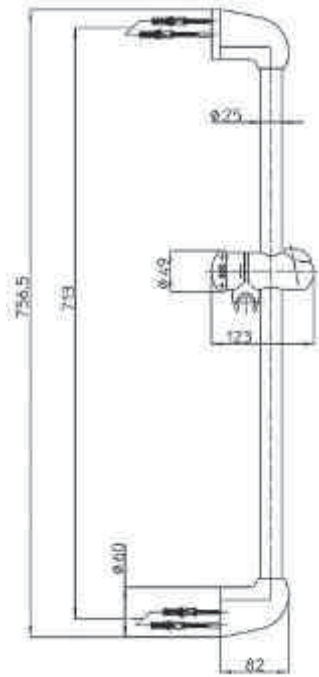

15 uds.



DE6000

Barra deslizante RENOVATION
latón.
Diam. 20 mm.

Cromo (51): 60,00

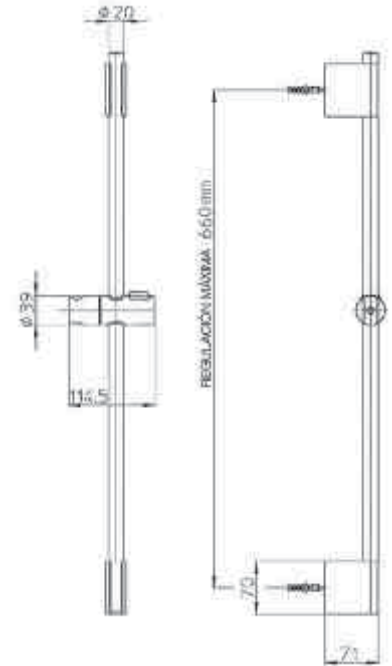

15 uds.



D72000

Barra deslizante YUMA latón/ABS.
Diam. 18 mm.

Cromo (51): 35,00

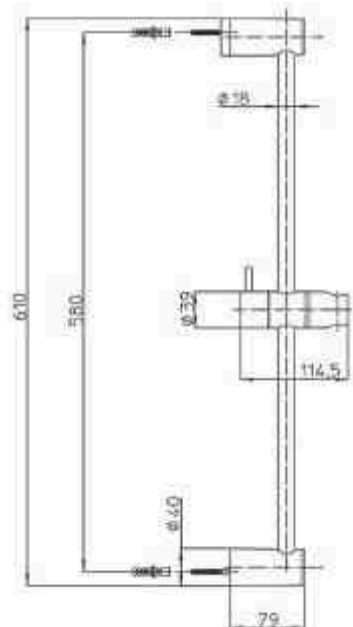

15 uds.



C12169

Kit ducha soporte con toma de agua + flexible CROMOLUX 175 cms.+ mango ducha MIXA/3.

Cromo (51): 125,00
 Negro mate (13): 162,00

15 uds.



C12250

Kit ducha soporte con toma de agua + flexible CROMOLUX 175 cms. + mango ducha ZEN latón.

Cromo (51): 85,00
 Negro mate (13): 110,00

15 uds.



C54169

Kit ducha soporte orientable con toma de agua + flexible doble grapado latón 175 cms. + mango ducha MIXA/3.

Cromo (51): 111,00

15 uds.



C54250

Kit ducha soporte orientable con toma de agua + flexible doble grapado latón 175 cms. + mango ducha ZEN latón.

Cromo (51): 71,00

15 uds.



C30169

Kit ducha soporte mural fijo ABS + flexible doble grapado latón 175 cms. + mango ducha MIXA/3.

Cromo (51): 82,00

15 uds.



C30250

Kit ducha soporte mural fijo ABS + flexible doble grapado latón 175 cms. + mango ducha ZEN latón.

Cromo (51): 42,00

15 uds.





C54255

Kit ducha soporte orientable con toma de agua + flexible doble grapado latón 175 cms. + mango ducha CUBE latón.

Cromo (51): 89,00

15 uds.



C12152

Kit ducha soporte con toma de agua + flexible CROMOLUX 175 cms. + mango ducha DUETTO-NEB.

Cromo (51): 85,00

15 uds.



C55255

Kit ducha soporte orientable CUBE + flexible doble grapado latón 175 cms. + mango ducha CUBE latón.

Cromo (51): 120,00

15 uds.



C54805

Kit ducha soporte orientable con toma de agua + flexible doble grapado latón 175 cms. + mango ducha SINCRONIA/2.

Cromo (51): 85,00

15 uds.

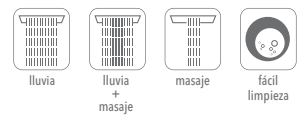

C30092

Kit ducha soporte mural fijo ABS + flexible doble grapado latón 175 cms. + mango ducha PETRA.

■ Cromo (51): 36,00
■ Blanco (06): 34,00

15 uds.



C30805

Kit ducha soporte mural fijo ABS + flexible doble grapado latón 175 cms. + mango ducha SINCRONIA/2.

Cromo (51): 56,00

15 uds.





A02035

Flexible reforzado latón
1/2" Hx1/2" H cónico.

150 cms. Cromo (51):	12,00
175 cms. Cromo (51):	15,00
200 cms. Cromo (51):	17,00

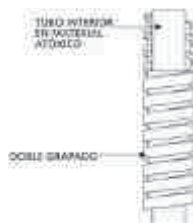

45 uds.

ALTA RESISTENCIA



A102035

Caja Pack 12 uds. flexible reforzado latón de 175 cms.

Cromo (51): 180,00



A04045

Flexible doble grapado latón
1/2" Hx1/2" H cónico.

100 cms. Cromo (51):	13,00
125 cms. Cromo (51):	15,00
150 cms. Cromo (51):	16,00
175 cms. Cromo (51):	20,00
200 cms. Cromo (51):	23,00

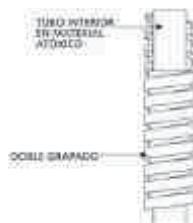

45 uds.

ALTA RESISTENCIA



A104045

Caja Pack 12 uds. flexible doble grapado latón de 175 cms.

Cromo (51): 240,00



A03045

Flexible doble grapado latón
1/2" Hx1/2" H cónico con acabados.

125 cms. Bronce (92):	53,00
125 cms. Oro (52):	63,00
125 cms. Oro rosa (46):	81,00
125 cms. Cromo negro (72):	75,00
125 cms. Oro rosa satinado (34):	88,00

175 cms. Bronce (92):	69,00
175 cms. Oro (52):	98,00
175 cms. Oro rosa (46):	115,00
175 cms. Cromo negro (72):	109,00
175 cms. Oro rosa satinado (34):	124,00

45 uds.

ALTA RESISTENCIA



A00048

Flexible doble grapado latón
ANTIENROLLABLE 1/2" Hx1/2" H
cónico con racor giratorio.

175 cms. Cromo (51): 23,00

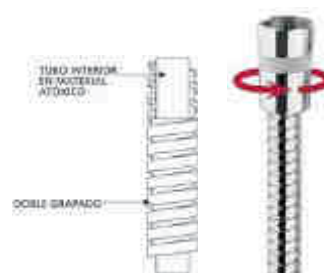

45 uds.

ALTA RESISTENCIA





A00170

Flexible CROMOLUX 1/2"Hx1/2"H cónico CROMO BRILLO.

150 cms. Cromo (51):	11,00
175 cms. Cromo (51):	12,00
200 cms. Cromo (51):	14,00

45 uds.

ALTA RESISTENCIA



A100170

Caja Pack 12 uds. flexible CROMOLUX de 175 cms.

Cromo (51):	144,00
-------------	--------



A00158D

Flexible CROMOLUX ANTIENROLLABLE 1/2"Hx1/2"H cónico con racor giratorio.

175 cms. Blanco mate (06):	22,00
175 cms. Negro mate (13):	22,00

45 uds.

ALTA RESISTENCIA



A00158A

Flexible CROMOLUX para kits bidé.

100 cms. Cromo (51):	12,00
100 cms. Blanco (06):	17,00
100 cms. Negro (13):	17,00

45 uds.

ALTA RESISTENCIA



A04047

Flexible doble grapado latón 3/8"Hx1/2"H cónico.

125 cms. Cromo (51):	18,00
175 cms. Cromo (51):	23,00
200 cms. Cromo (51):	24,00

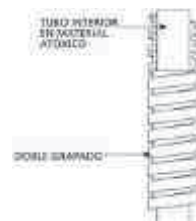

45 uds.

ALTA RESISTENCIA

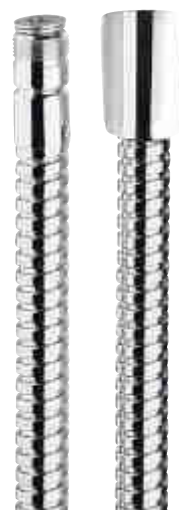

A02053

Flexible doble grapado latón 15x1Mx1/2"H cónico.

125 cms. Cromo (51):	20,00
175 cms. Cromo (51):	23,00
200 cms. Cromo (51):	24,00

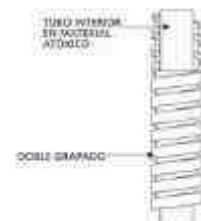

45 uds.

ALTA RESISTENCIA







C04047
Kit bidé monomando.

Cromo (51): 208,00

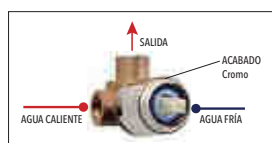

6 uds.



C04050
Kit bidé monomando QUADRI.

Cromo (51): 288,00

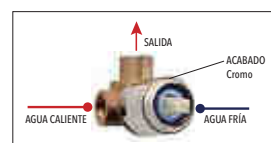
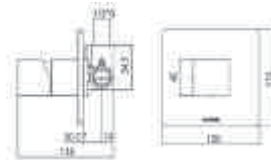

6 uds.



C04048
Kit bidé monomando.

Cromo (51): 235,00

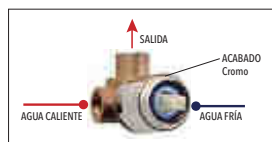
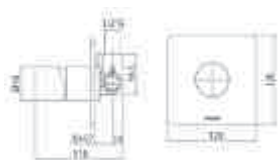

6 uds.



E37018
Kit bidé con monomando progresivo.

Cromo (51): 401,00

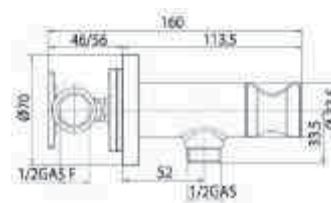

6 uds.



Z00539
Kit bidé mural con placa IDEAL.

Cromo (51): 297,00

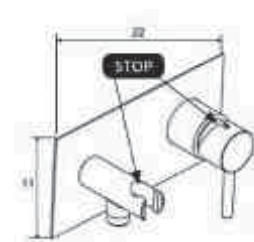

6 uds.



C89001

Kit bidé con alimentación a inodoro y flexo doble grapado 100 cms.

Cromo (51): 97,00

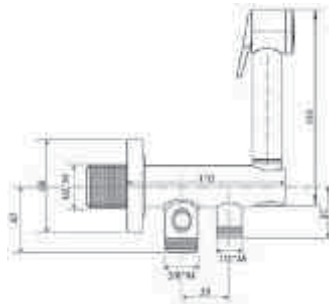

6 uds.



C55001

Kit bidé con mango CUBE BRASS, soporte con toma CUBE y flexo reforzado 100 cms.

Cromo (51): 129,00

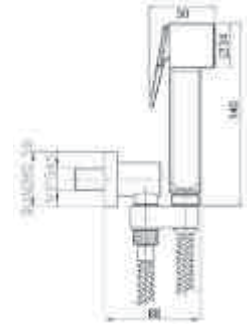

6 uds.



C69001

Kit bidé con soporte/toma de agua con STOP y flexo doble grapado 100 cms.

Cromo (51): 77,00

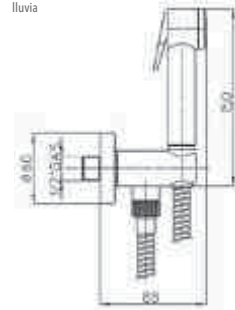

6 uds.



C67003

Kit bidé mural con alimentación a inodoro inferior con STOP y flexo reforzado 100 cms.

Cromo (51): 56,00

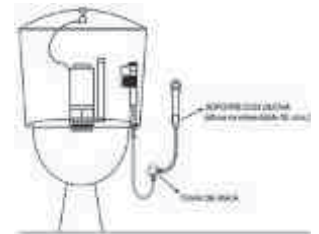

6 uds.



E57006

Kit bidé con llave de paso, soporte orientable y flexo doble grapado 125 cms.

Cromo (51): 103,00

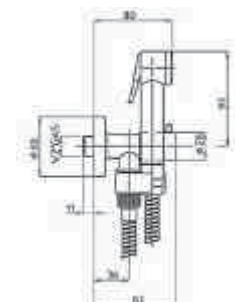

6 uds.



C04045

Kit bidé con mango NIKITA, soporte y flexo reforzado 100 cms.

Cromo (51): 54,00

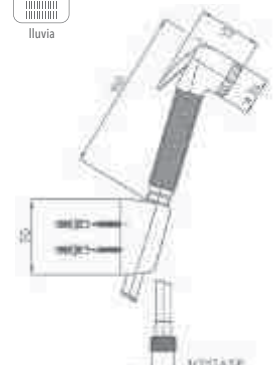

6 uds.



C04044

Kit bidé con mango PALOMA, soporte y flexo reforzado 100 cms.

Cromo (51): 27,00

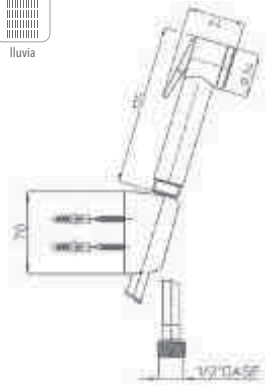

6 uds.



C04042

Kit bidé con mango GAIA, soporte y flexo reforzado 100 cms.

Cromo (51): 64,00

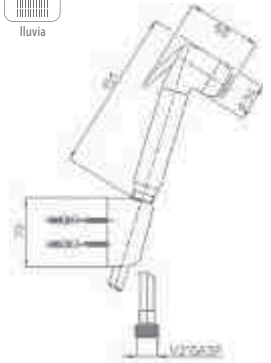

6 uds.



CA3001

Kit bidé con mango CUBE BRASS, soporte y flexo reforzado 100 cms.

Cromo (51): 90,00

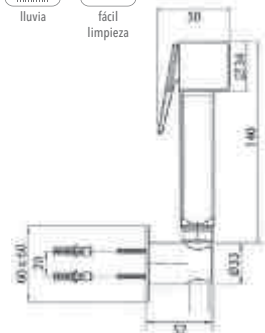

6 uds.



C98014

Kit bidé con soporte de cabezal y flexo reforzado 100 cms.

Cromo (51): 28,00

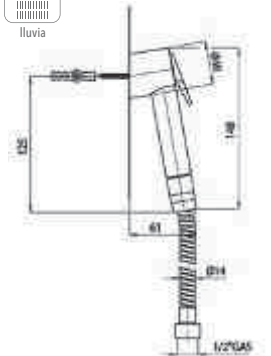

6 uds.



C04043

Kit bidé con mango TALITA-GOM, soporte y flexo reforzado 100 cms.

Cromo (51): 63,00

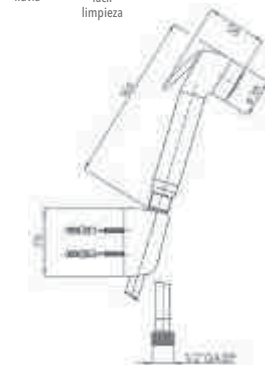

6 uds.



C89002

Kit HIDROESCOBILLA con alimentación a inodoro con STOP y flexo doble grapado 100 cms.

Cromo (51): 95,00



chorro aireado

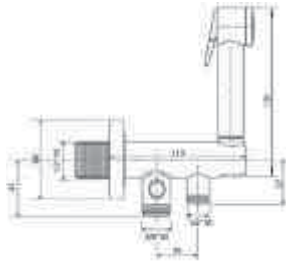

6 uds.



C67004

Kit HIDROESCOBILLA con alimentación a inodoro. Inferior con STOP y flexo reforzado 100 cms.

Cromo (51): 55,00



chorro aireado

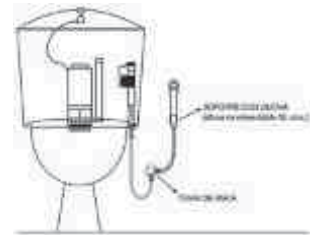

6 uds.



C69002

Kit HIDROESCOBILLA con soporte/ toma de agua con STOP y flexo doble grapado latón 100 cms.

Cromo (51): 76,00



chorro aireado

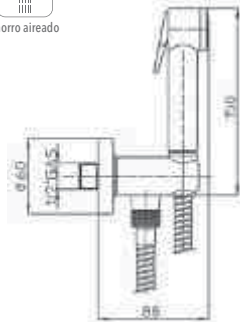

6 uds.



B00444

Mango PALOMA ABS HIDROESCOBILLA con STOP.

Cromo (51): 13,00



chorro aireado

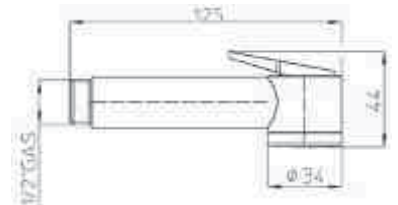

6 uds.



C98015

Kit HIDROESCOBILLA con soporte de cabezal y flexo reforzado 100 cms.

Cromo (51): 28,00



chorro aireado

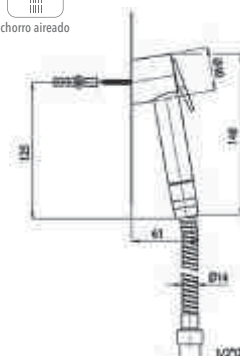

6 uds.



B00442

Mango PALOMA ABS con STOP.

Cromo (51): 12,00

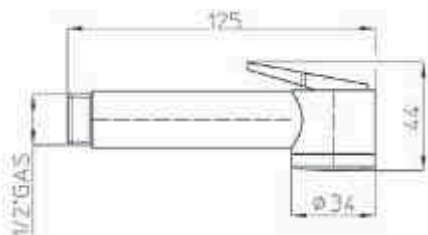

15 uds.



B00475

Mango latón CUBE BRASS con STOP.

Cromo (51): 54,00

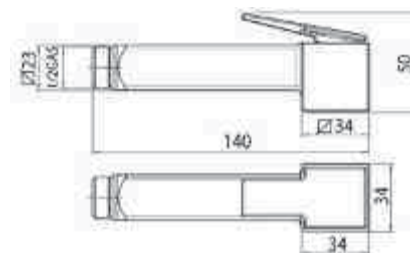

15 uds.



B00470

Mango PALOMA latón con STOP.

- Cromo (51): 61,00
- Cromo negro (72): 113,00
- Oro rosa (46): 129,00
- Oro rosa satinado (34): 138,00
- Negro mate (13): 79,00
- Blanco mate (24): 79,00
- Oro (52): 99,00

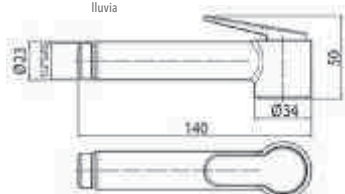

15 uds.



B00650

Mango latón NIKITA con STOP.

Cromo (51): 39,00

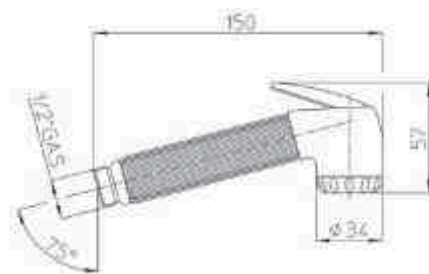

15 uds.



B00661

Mango GAIA latón con STOP.

Cromo (51): 49,00

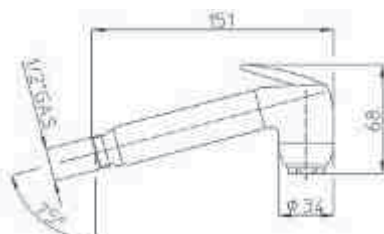

15 uds.



B00653

Mango latón TALITA-GOM con STOP.

Cromo (51): 48,00

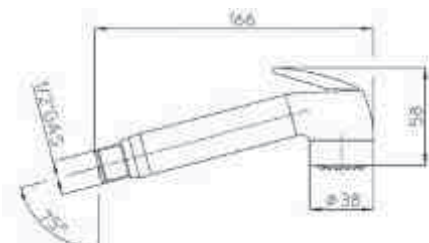

15 uds.

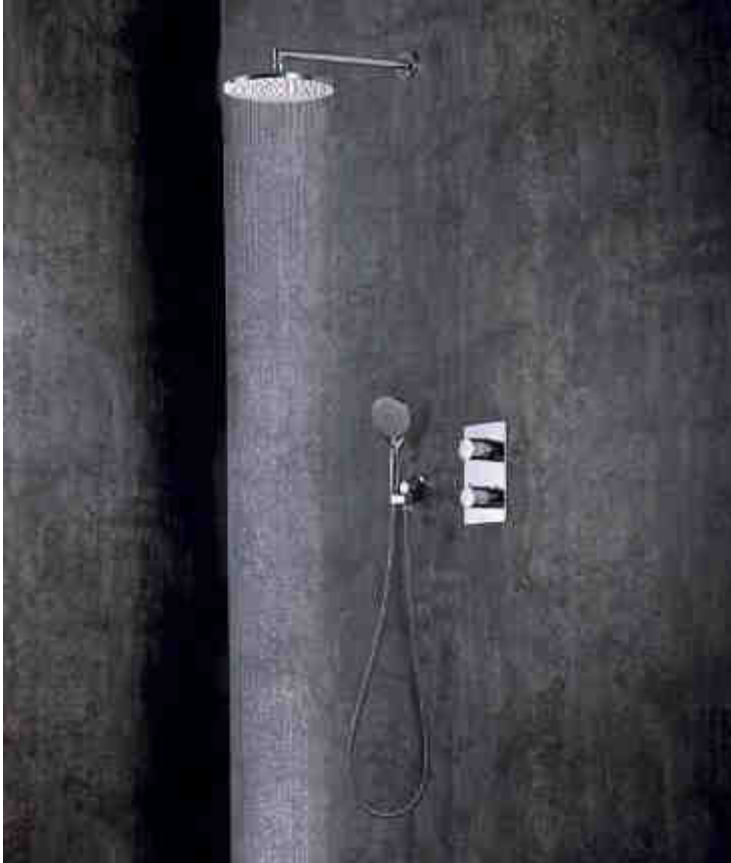

M00600

- Termostato 2 salidas COSMO.
- Rociador diam. 230 mm.
- Mango SINCRONIA/2.
- Soporte con toma.

Cromo (51): 835,00



M00606

- Termostato 2 salidas CUBE.
- Rociador 230 x 230 mm.
- Mango AGUA-LIFE.
- Soporte con toma.

Cromo (51): 962,00



M00602

- Termostato 3 salidas COSMO.
- Rociador diam. 280 mm.
- Conjunto ducha MIXA.
- Toma de agua.
- Duchitas laterales TONDO-FLAT.

Cromo (51): 1.276,00



M00608

- Termostato 3 salidas CUBE.
- Rociador 280 x 280 mm.
- Conjunto ducha AGUA-LIFE.
- Toma de agua.
- Duchitas laterales CUBIC-FLAT.

Cromo (51): 1.354,00



M00604

Termostato 4 salidas COSMO.

- Rociador diam. 280 mm.
- Conjunto ducha MIXA.
- Toma de agua.
- Duchitas laterales TONDO-FLAT.
- Cascada 250 mm.

Cromo (51): 1.423,00



M00610

Termostato 4 salidas.

- Rociador 280 x 280 mm.
- Conjunto ducha AGUA-LIFE.
- Toma de agua.
- Duchitas laterales CUBIC-FLAT.
- Cascada 120x155 mm.

Cromo (51): 1.857,00



M00616

- Termostato 2 salidas SYNCRO.
 - Rociador 450x200 mm.
 - Mango SINCRONIA/2.
 - Soporte con toma.

Cromo (51): 2.004,00



M00618

- Termostato 3 salidas SYNCRO.
 - Rociador 450x200 mm.
 - Conjunto ducha SINCRONIA
 - Toma de agua.
 - Duchitas laterales CUBIC-FLAT.

Cromo (51): 2.433,00

Características de instalación

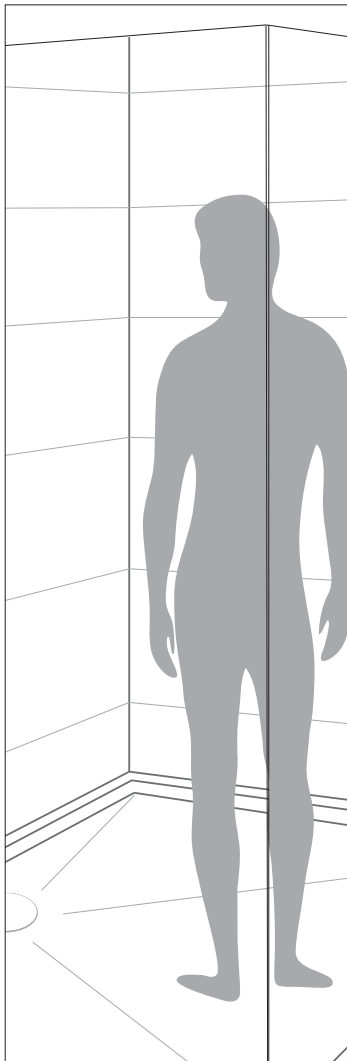

	Altura de la persona	cm	160	170	180	190	200
	Rociador	cm	210	210	220	230	240
	Barra ducha	cm	220	220	230	240	250
	Mezclador	cm	115	120	125	130	135
	Duchas laterales superiores	cm	130	140	150	160	170
	Duchas laterales medias	cm	95	105	115	125	135
	Duchas laterales inferiores	cm	60	70	80	90	95
	Lavapiés / Caño mural	cm	25	25	30	30	35
	Soportes mango ducha	cm	115	120	125	130	135





L00860

BAMBOO-POOL progresiva cascada + progresivo pies.

Acero Inox Cromo (51): 6.507,00

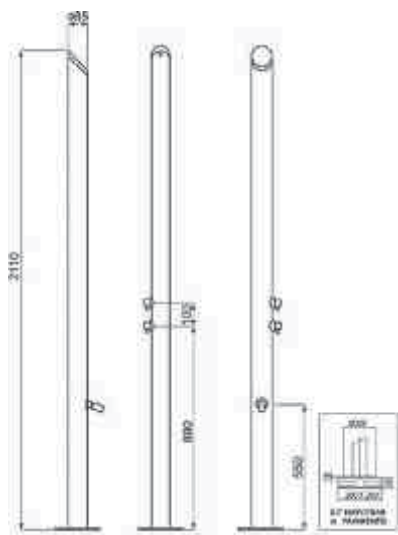

cascada



L00362

NEK progresivo rociador + progresivo pies.

Acero Inox Cromo (51): 2.201,00

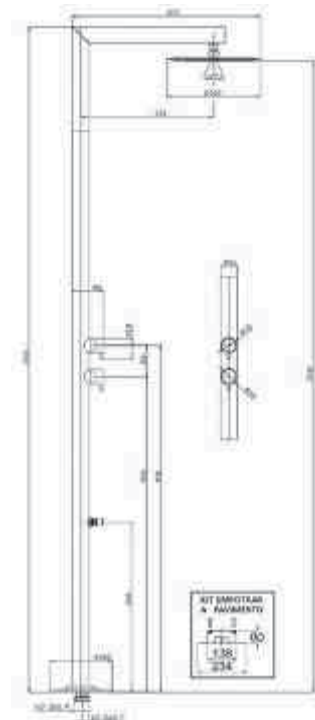

lluvia



L00861

ARCH-POOL progresiva + progresivo pies.

Acero Inox Cromo (51): 6.968,00

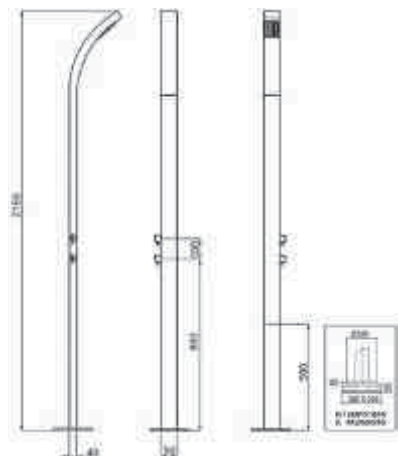

lluvia



cascada



L00815

DINAMIC con doble llave 1/2 con regulación de temperatura y caudal.

Acero Inox Cromo (51): 1.799,00

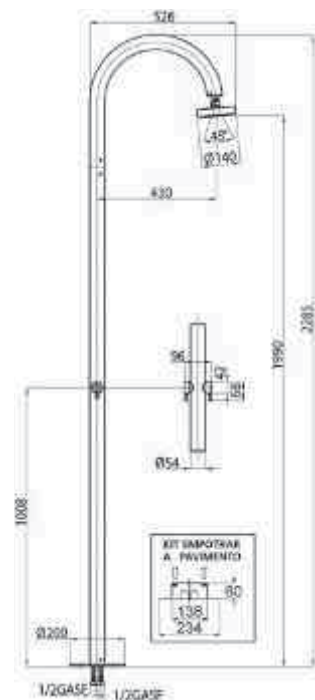

lluvia



Entrada de agua

L00356

TWIGGY progresivo rociador + progresivo pies.

- Acero Inox Cromo (51): 2.506,00
- Acero Inox Satinado (28): 2.579,00

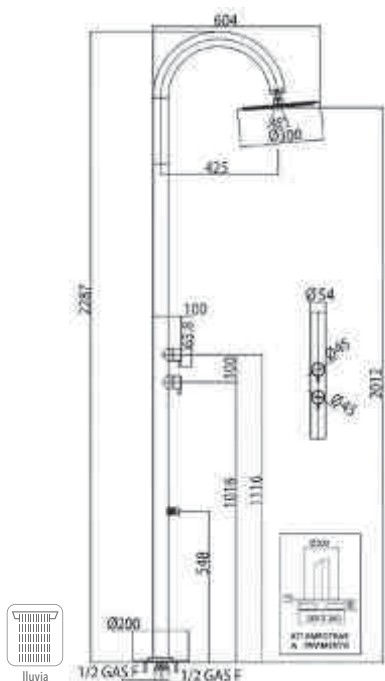

Entrada de agua

INL001

Columna mini piscina y/o bañera con grifería progresiva.

- Acero Inox Satinado (28): 1.800,00

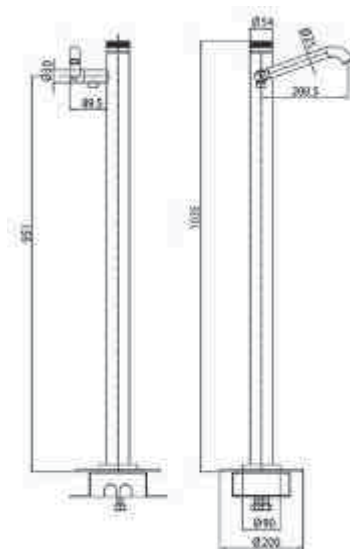

L00862

BAMBOO-POOL RENOVATION con doble llave 1/2 cascada o pies.

Acero Inox Cromo (51): 6.016,00

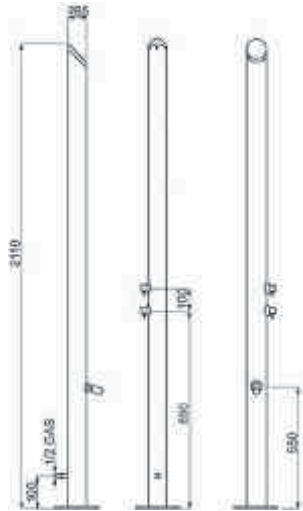

L00814

DINAMIC con llave 1/2.

Acero Inox Cromo (51): 1.570,00

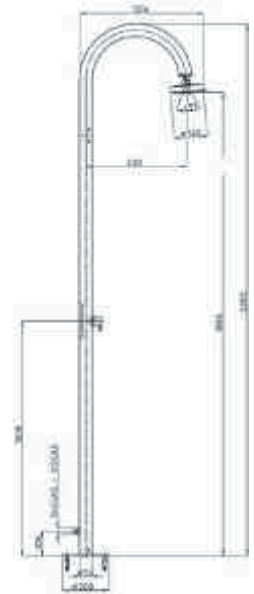

COMPLEMENTOS DUCHA

L00863

ARCH-POOL RENOVATION con doble llave 1/2 cascada y rociador.

Acero Inox Cromo (51): 6.486,00

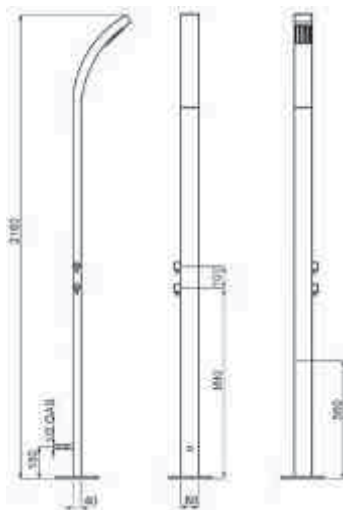

L00822

POOL-FLOOR temporizado.

Acero Inox Cromo (51): 1.437,00

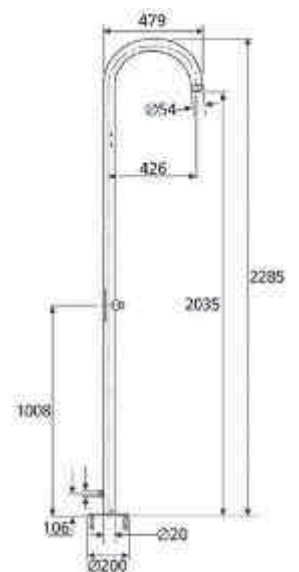



Entrada de agua

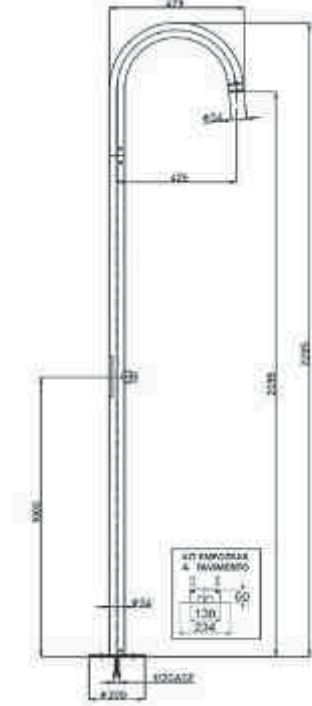

L00831

POOL FLOOR temporizado.

Acero Inox Cromo (51): 1.862,00



Entrada de agua

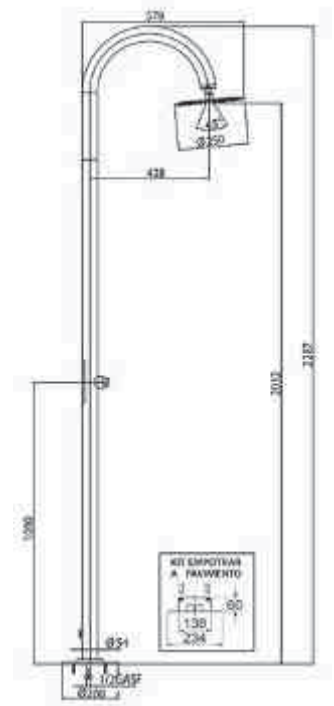

L00846

TWIGGY temporizado.

Acero Inox Cromo (51): 2.019,00



I00197

Duchita lateral TONDO orientable.

Cromo (51): 70,00



15 uds.

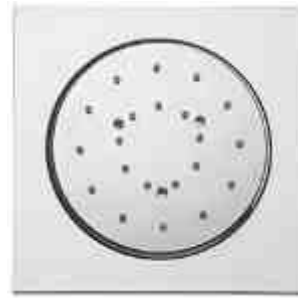

I00198

Duchita lateral CUBE orientable.

Cromo (51): 70,00

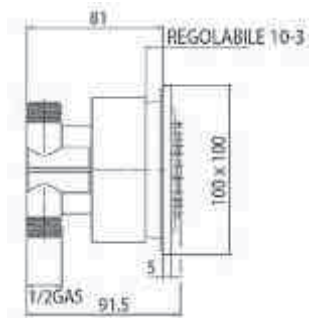

15 uds.

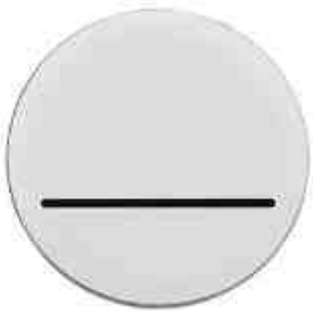

E86911

Cascada OLÈ ROUND.

Cromo (51): 197,00

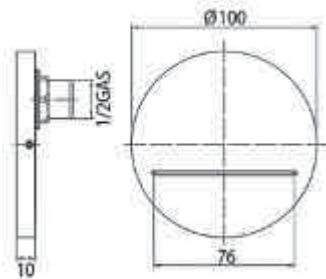

15 uds.

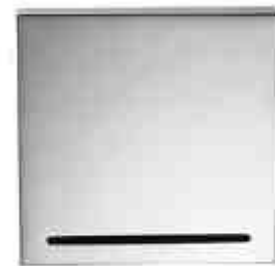

E86908

Cascada OLÈ SQUARE.

Cromo (51): 214,00

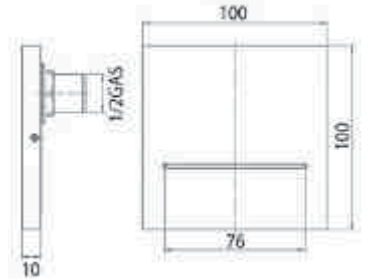

15 uds.



I00175

Duchita lateral TONDO/RASO.

Cromo (51): 105,00

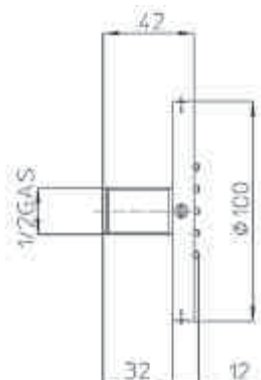

15 uds.

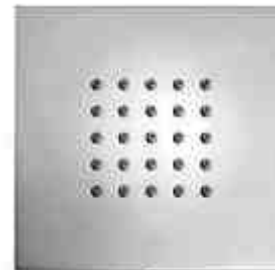

I00176

Duchita lateral QUADRO/RASO.

Cromo (51): 113,00

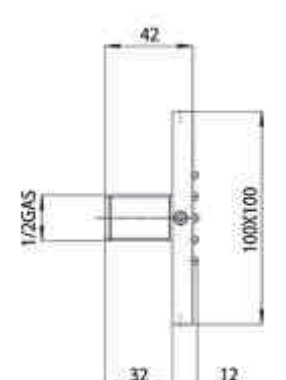

15 uds.



I00136

Duchita lateral KUBICA/VAPOR.

Cromo (51): 25,00

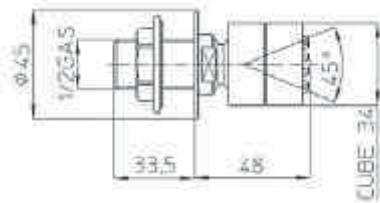

30 uds.



I00148

Duchita lateral CYLINDRICA/MASAJE.

Cromo (51): 24,00

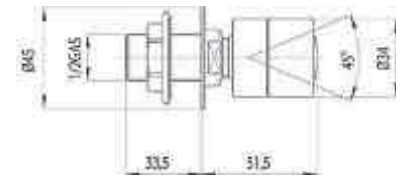

30 uds.



I00142

Duchita lateral KUBICA/MASAJE.

Cromo (51): 25,00

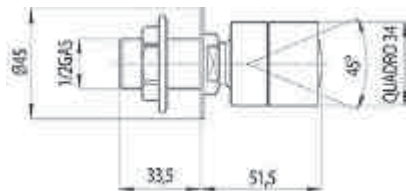

30 uds.



I00102

Duchita lateral DUO SPRAY.

Cromo (51): 30,00

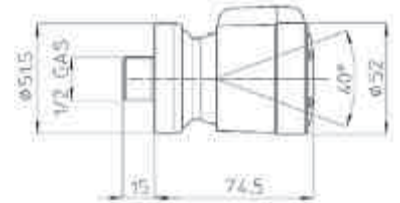

30 uds.



I00138

Duchita lateral CYLINDRICA/VAPOR.

Cromo (51): 49,00

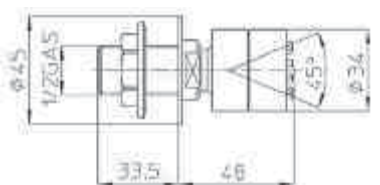

30 uds.



I00151

Duchita lateral MINI NEB.

Cromo (51): 11,00

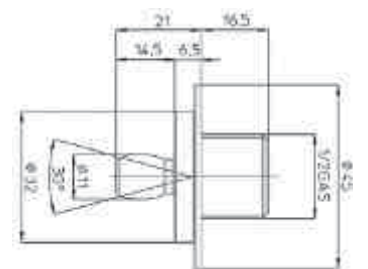

30 uds.



I00153

Duchita lateral MINI MAS.

Cromo (51): 17,00



masaje

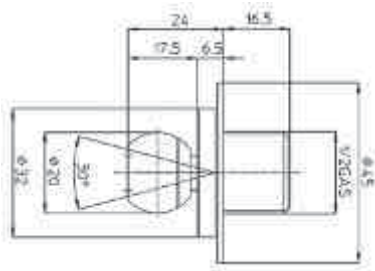

30 uds.



I00214

Duchita lateral NEBULIZAIR.

Cromo (51): 55,00



nebulizado



fácil
limpieza

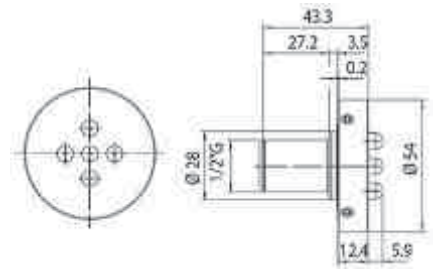

30 uds.



CD4000

Soporte duplex latón.

Cromo (51): 66,00

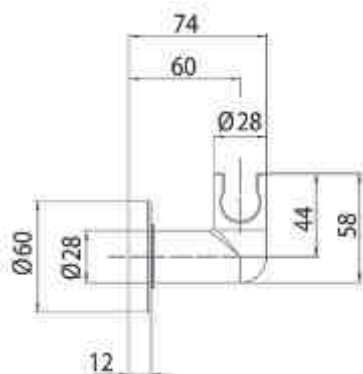

15 uds.



CD5000

Soporte duplex con toma de agua todo latón.

Cromo (51): 76,00

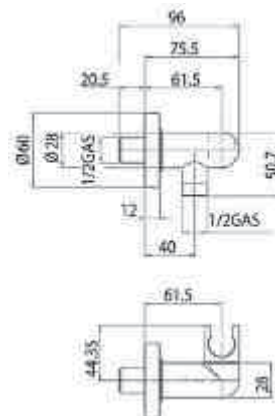

15 uds.



C51000

Soporte dúplex orientable cuadrado latón.

Cromo (51): 60,00

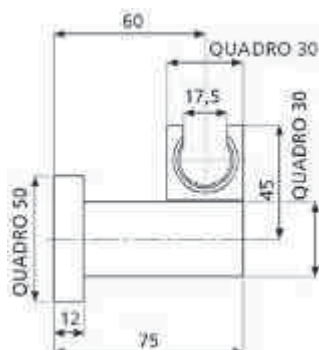

15 uds.



CD2000

Soporte orientable CUBE con toma de agua todo latón.

Cromo (51): 89,00

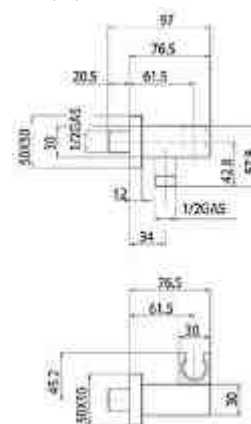

15 uds.



C17000

Toma de agua con soporte orientable retro.

Cromo (51): 42,00
 Bronce (92): 89,00
 Oro (52): 92,00

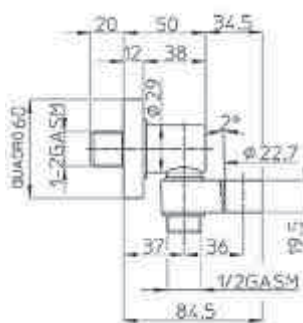

15 uds.



C54000

Soporte orientable con toma de agua latón.

Cromo (51): 32,00



15 uds.



CB7000

Soporte orientable ABS.

Cromo (51): 12,00

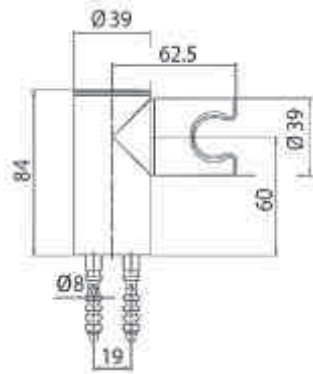

30 uds.



C95000

Soporte dúplex orientable ABS.

Cromo (51): 10,00
Inox (19): 30,00

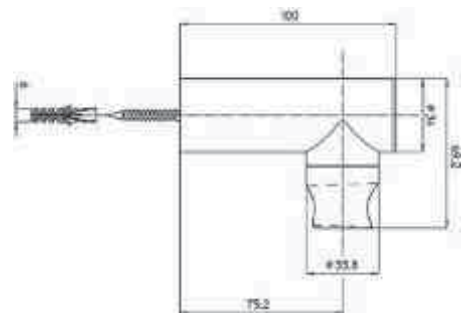

30 uds.



CA3000

Soporte fijo latón.

Cromo (51): 24,00

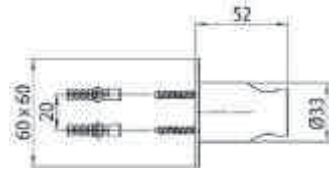

30 uds.



C04000

Soporte fijo ABS.

Cromo (51): 3,00
Blanco (06): 2,00

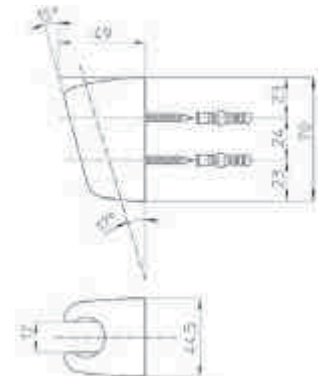

30 uds.



C03000

Soporte fijo ABS.

Cromo (51): 3,00
Blanco (06): 2,00

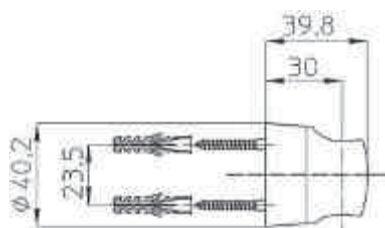

30 uds.



C50000

Soporte fijo latón con tuerca.

Cromo (51): 23,00

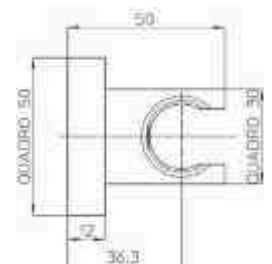

30 uds.



C12000

Toma de agua latón.

- Cromo (51): 44,00
- Negro mate (13): 57,00

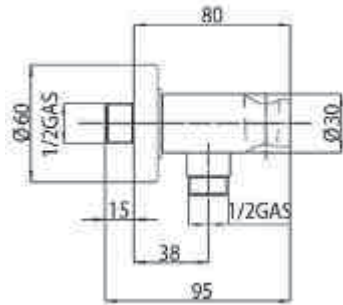

15 uds.



V00240

Toma de agua CUBE latón.

- Cromo (51): 29,00

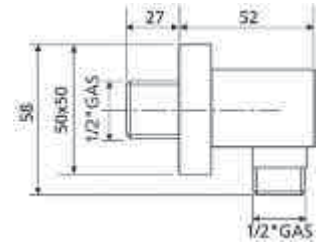

15 uds.



V00001

Toma de agua lujo latón.

- Cromo (51): 20,00

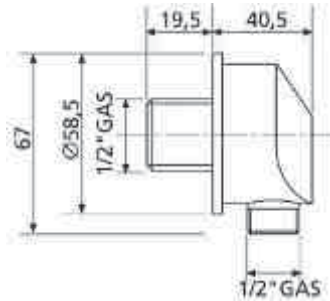

15 uds.



V00011

Toma de agua latón.

- Cromo (51): 11,00

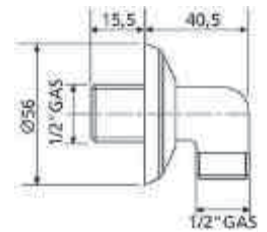

15 uds.



V00228

Toma de agua minimalista latón.

- Cromo (51): 18,00
- Blanco (06): 33,00

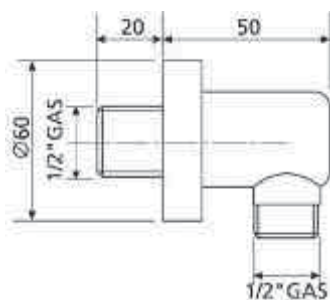

15 uds.



V00014

Toma de agua CHARLESTON latón.

- Cromo (51): 22,00
- Bronce (92): 34,00
- Oro (52): 35,00
- Níquel (85): 25,00

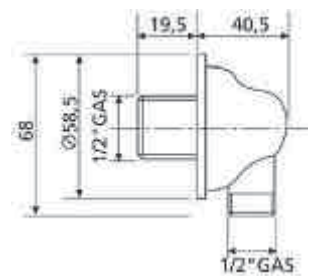

15 uds.



R00005

Aireador AHORRO 22x1H.

Cromo (51): 4,00



Caja 2 uds.

100 uds.



R00011

Racor para mango ducha o rociador 1/2"Hx1/2"M.

Cromo (51): 3,00



50 uds.



Blister 1 ud.



R00007

Aireador AHORRO 24x1H.

Cromo (51): 5,00



Caja 2 uds.

100 uds.



R00012

Llave de cierre 1/2"Hx1/2"M.

Cromo (51): 6,00



50 uds.



Blister 1 ud.



R00002

Duchita 2 posiciones ahorro. Con adaptador 22x1H y 24x1H.

Cromo (51): 9,00



Blister 1 ud.

50 uds.



R00009

Duchita 2 posiciones con flexible con adaptador para 22x1H y 24x1H.

Cromo (51): 8,00

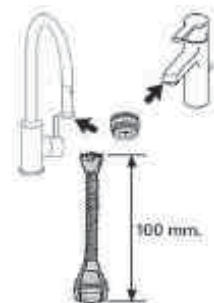

50 uds.



Blister 1 ud.



L00085

Rótula con aireador 2 posiciones 22x1H y reducción a 1/2"H.

Cromo (51): 5,00

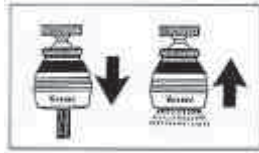

Blister 1 ud.

50 uds.



V00160

Rótula 1/2"Hx1/2"M.

Cromo (51): 9,00

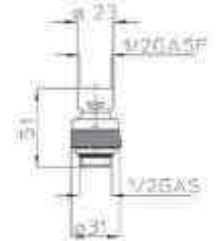

Blister 1 ud.

15 uds.



L00273

Aireador con alargo flexible 22x1H y reducción a 24x1M.

Cromo (51): 8,00

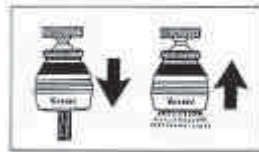

Blister 1 ud.

50 uds.



E59000

Llave de cierre 1/2"Hx1/2"M.

Cromo (51): 6,00



Blister 1 ud.

15 uds.



E60500

Desviador 3 vías 1/2"Mx1/2"Mx1/2"H.

Cromo (51): 31,00

E61500

Desviador 3 vías 1/2"Mx3/4"Mx3/4"H.

Cromo (51): 31,00

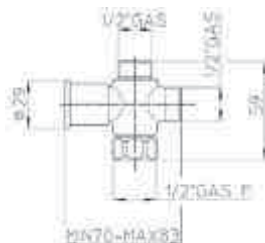

Caja 1 ud.

15 uds.



V00180

Rácor giratorio para flexible de ducha 1/2"Hx1/2"M.

Cromo (51): 6,00



Blister 1 ud.

50 uds.



L000510

Aireador 22x1H.
Blister 1 ud.

Cromo (51): 3,00



L000512

Aireador 22x1H.
Caja 2 uds.

Cromo (51): 5,00



L000511

Aireador 22x1H.
Caja 10 uds.

Cromo (51): 27,00



V00105

Jabonera redonda para barra
diam. 18, 20 y 25 mm.

Acrílico (51): 9,00

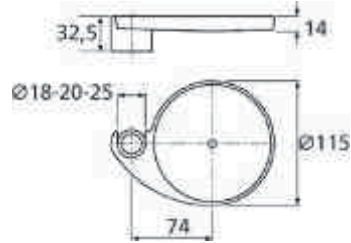

L000530

Aireador 24x1H.
Blister 1 ud.

Cromo (51): 3,00



L000532

Aireador 24x1H.
Caja 2 uds.

Cromo (51): 5,00



L000531

Aireador 24x1H.
Caja 10 uds.

Cromo (51): 27,00



V00106

Jabonera cuadrada para barra
diam. 18, 20 y 25 mm.

Acrílico (51): 12,00



L00055

Aireador 28x1M para bañera.

Cromo (51): 4,00



V00116

Jabonera rectangular para barra
diam. 18, 20 y 25 mm.

Acrílico (51): 13,00

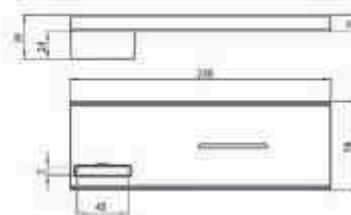



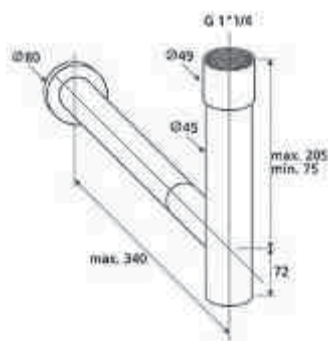

700.135.5
TOTEM lavabo latón.

- Cromo (51): 76,00
- Inox (19): 102,00



30 uds.

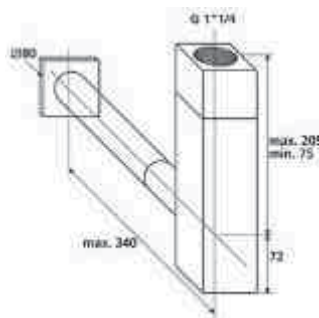

800.136.5
OPERA lavabo latón.

- Cromo (51): 95,00



30 uds.

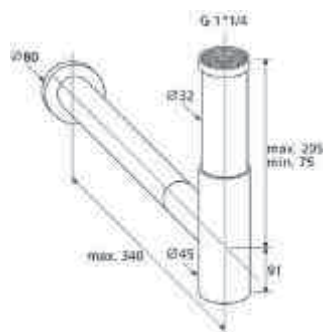

710.135.5
TOTI lavabo latón.

- Cromo (51): 39,00
- Negro mate (13): 140,00
- Blanco mate (24): 140,00
- Oro (52): 102,00
- Oro rosa (46): 150,00
- Cromo negro (72): 160,00



30 uds.

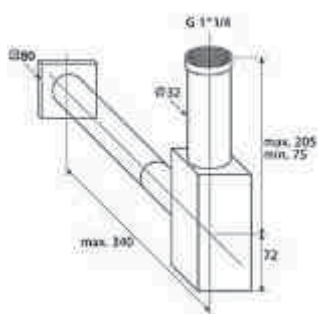

810.136.5
QUASAR lavabo latón.

- Cromo (51): 88,00



30 uds.

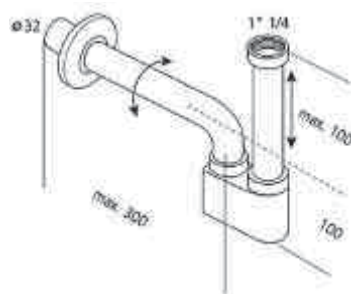

514.135.5
MULTI-JOB lavabo latón.

- Cromo (51): 51,00



15 uds.

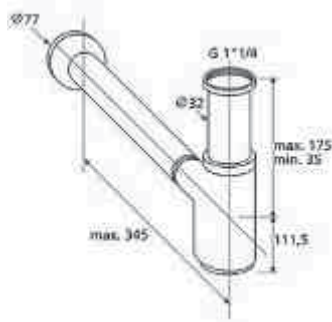

919.639.6
GENESIS lavabo latón.

	Cromo (51):	39,00
	Blanco (06):	56,00
	Bronce (92):	68,00
	Oro (52):	79,00



30 uds.

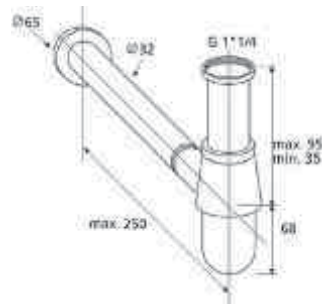

19.225.5
BOTELLA lavabo latón.

Cromo (51):	16,00
-------------	-------



60 uds.

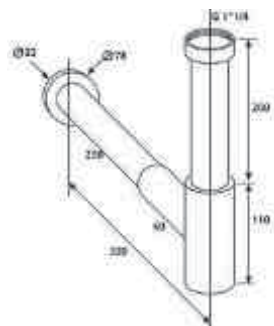

916.324.5
MAO MAO lavabo latón.

Cromo (51):	34,00
-------------	-------



30 uds.

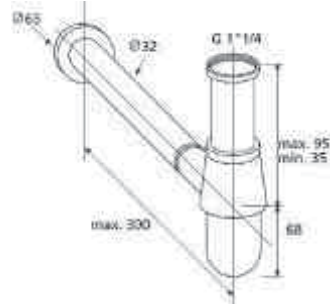

19.235.5
BOTELLA lavabo latón.

Cromo (51):	18,00
-------------	-------



60 uds.

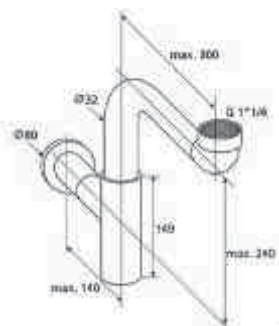

711.135.5
TOTI-EXEL lavabo latón.

Cromo (51):	84,00
-------------	-------



15 uds.

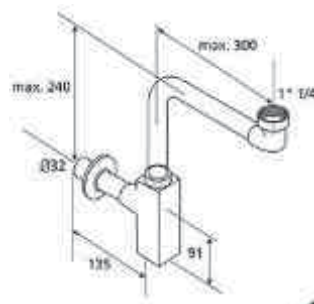

811.136.5
QUASAR-EXEL lavabo latón.

Cromo (51):	106,00
-------------	--------



15 uds.

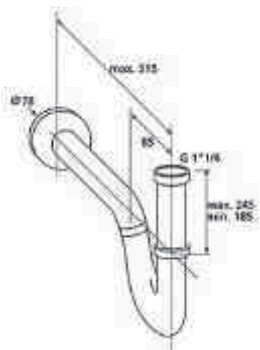

26.925.5
HALLEY lavabo latón.

Cromo (51): 16,00



30 uds.

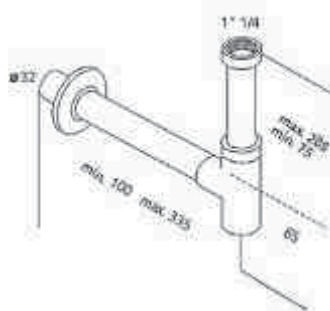

713.135.5
TOTI bidé latón.

Cromo (51): 42,00



30 uds.

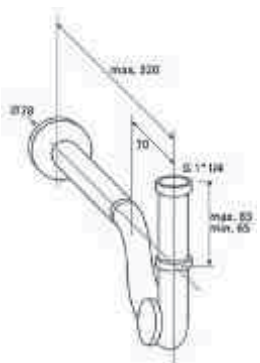

390.223.5
MINI lavabo latón.

Cromo (51): 20,00



60 uds.

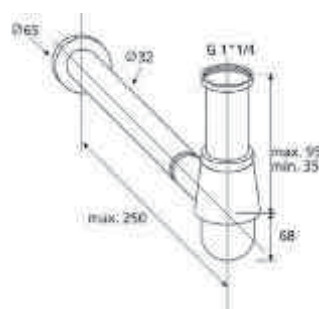

519.225.5
GENESIS bidé latón.

Cromo (51): 15,00
 Bronce (92): 36,00
 Oro (52): 40,00



60 uds.



80.150.5
Tubo latón entrada sifón.
Diámetro 32 mm. Largo 150 mm.

Cromo (51): 6,00

80.400.5
Tubo latón entrada sifón.
Diámetro 32 mm. Largo 400 mm.

Cromo (51): 7,00

30 uds.



78.250.5
Tubo latón salida sifón.
Diámetro 32 mm. Largo 250 mm.

Cromo (51): 6,00

78.300.5
Tubo latón salida sifón.
Diámetro 32 mm. Largo 300 mm.

Cromo (51): 8,00

78.400.5
Tubo latón salida sifón.
Diámetro 32 mm. Largo 400 mm.

Cromo (51): 12,00

30 uds.



530.750.5

Clicker universal.

- Cromo (51): 16,50
- Negro mate (13): 80,00
- Blanco mate (24): 80,00
- Oro (52): 90,00
- Oro rosa (46): 100,00
- Cromo negro (72): 75,00

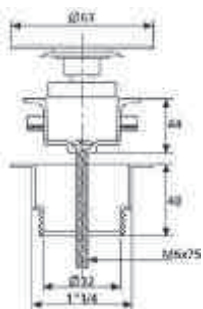

30 uds.



8120.387.5

Desagüe lavabo giratorio TWIST, latón universal. Tapón diam. 70 mm.

Cromo (51): 14,00

8120.487.5

Desagüe lavabo giratorio TWIST, inox universal. Tapón diam. 70 mm.

Inox (19): 13,00



30 uds.



540.750.5

Clicker QUADRI universal.

Cromo (51): 32,00

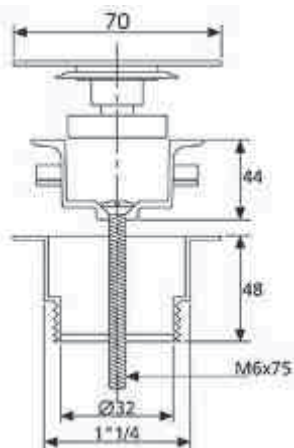

30 uds.



8034.322.5

Mini clicker CHAMPIÑÓN universal.

Cromo (51): 15,00

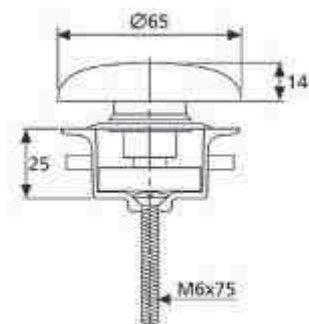

30 uds.



7530.750.5

Clicker FOUR SEASONS universal.

Cromo (51): 34,00



30 uds.



530.329.5

Sustitución clicker CHAMPIÑÓN universal.

Cromo (51): 11,00

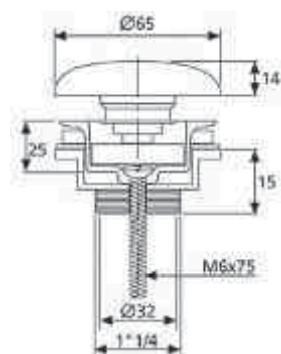

30 uds.



530.360.5

Desagüe lavabo CLICKER.
Con rebosadero alto 60 mm.

- Cromo (51): 18,00
- Bronce (92): 38,00
- Oro (52): 46,00
- Inox (19): 38,00

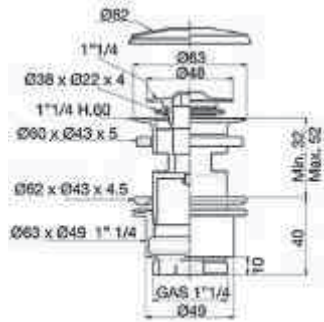

30 uds.



530.300.5

Desagüe lavabo CLICKER.
Sin rebosadero alto 35 mm.

- Cromo (51): 19,00

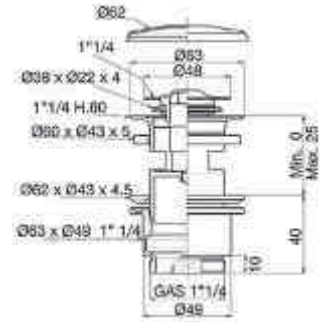

30 uds.



530.960.5

Desagüe lavabo CLICKER.
Sin rebosadero alto 60 mm.

- Cromo (51): 19,00

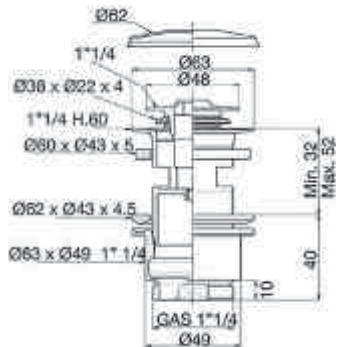

30 uds.



530.320.5

Desagüe lavabo CLICKER.
Sin rebosadero alto 90 mm.

- Cromo (51): 24,00

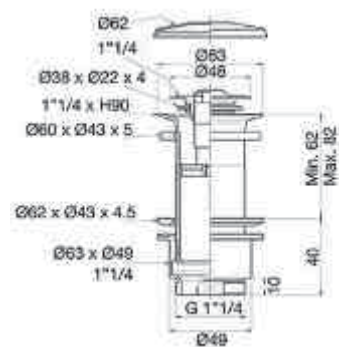

30 uds.



8120.380.5

Tapón desagüe lavabo TWIST.

- Cromo (51): 11,00

8120.480.5

Tapón desagüe lavabo TWIST.

- Inox (19): 10,00



60 uds.

NOTA: Se suministra con dos juntas para facilitar adapta a todo tipo de piletas.



UD-425S

Desagüe lavabo silencioso UP&DOWN UNIVERSAL.

Cromo (51): 37,00

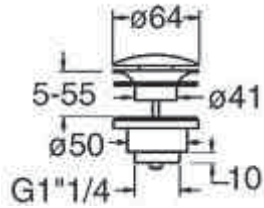

30 uds.



WA-334

Desagüe lavabo UP&DOWN UNIVERSAL ABS.

Cromo (51): 24,00

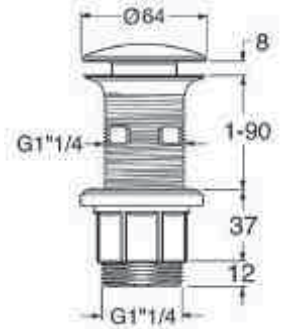

30 uds.



UD-389S

Desagüe lavabo silencioso UP&DOWN UNIVERSAL. Con rebosadero.

Cromo (51): 41,00

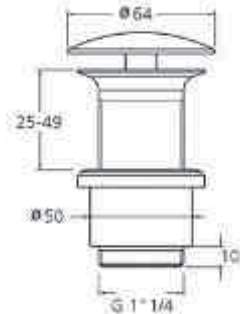

30 uds.



WA-335

Desagüe lavabo UP&DOWN con sifón incorporado UNIVERSAL.

Cromo (51): 273,00

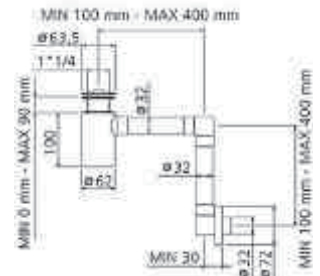

15 uds.



UD-830

Desagüe lavabo UP&DOWN NO RETURN SYSTEM. Sin rebosadero.

Cromo (51): 45,00

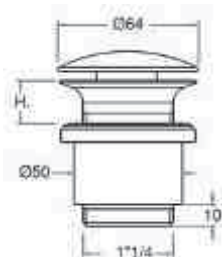

30 uds.



PP-130

Tubo corrugado INOX. Largo 800 mm. Con adaptadores para tubo PVC.

Cromo (51): 83,00

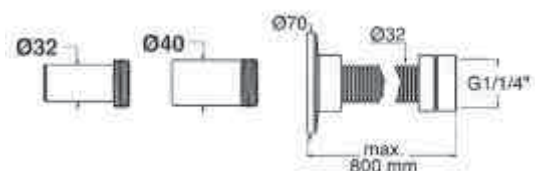

20 uds.

**WA-034S**

Desagüe lavabo UP&DOWN UNIVERSAL especial para poder encolar tapón de su producción. Pileta y contrapileta ABS.

Cromo (51): 26,00

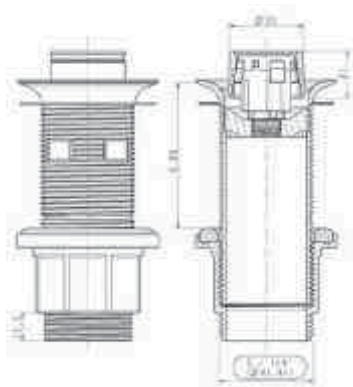

30 uds.

**UD-325S**

Desagüe lavabo universal ABS CROMO con sifón incorporado y tubo corrugado para montar tapón de su producción.

Cromo (51): 65,00

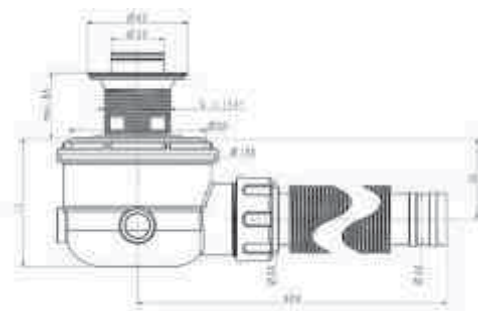

30 uds.

**UD-431S**

Desagüe lavabo UP&DOWN para montar tapón de su producción.

Cromo (51): 32,00

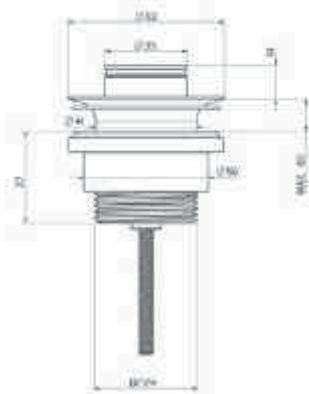

30 uds.

**UD-531**

Desagüe lavabo 1"1/4 fijo para montar tapón con su producción.

Cromo (51): 24,00

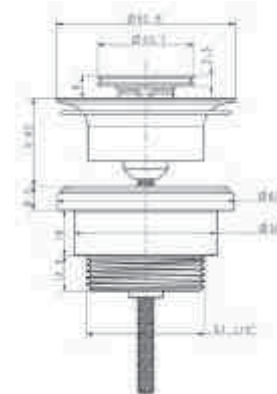

30 uds.

**UD-152**

Desagüe lavabo UP&DOWN con sifón salvaespacios.

Cromo (51): 63,00

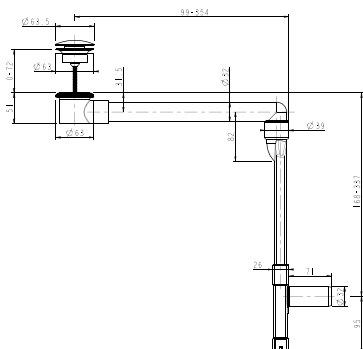

30 uds.

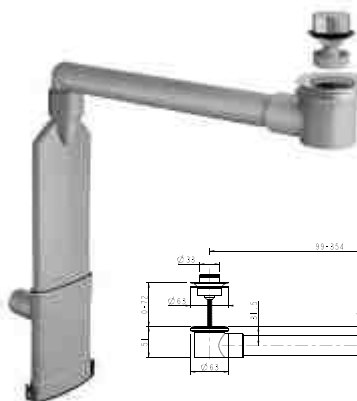
**UD-155**

Desagüe lavabo UP&DOWN con sifón salvaespacios para montar tapón de su producción.

Cromo (51): 49,00

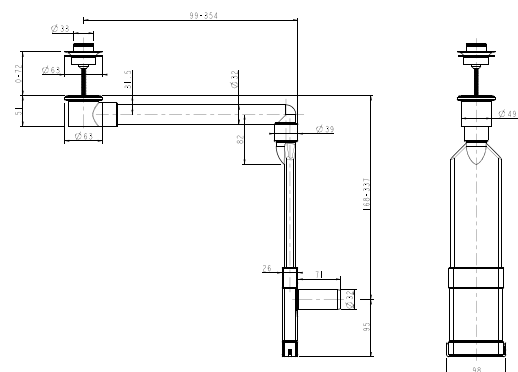

30 uds.



542.742.5

Desagüe lavabo libre apertura UNIVERSAL.

Cromo (51): 17,00

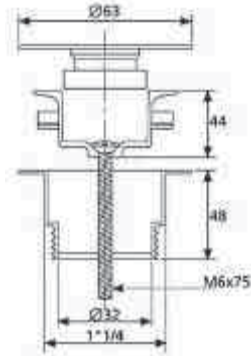

30 uds.



555.096.5

Desagüe lavabo rejilla. Sin rebosadero alto 60 mm.

Cromo (51): 11,00

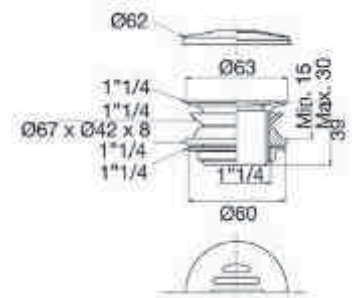

30 uds.



147.555.5

Desagüe lavabo libre apertura alto 60 mm.

Cromo (51): 19,00



30 uds.



147.955.5

Desagüe lavabo libre apertura alto 90 mm.

Cromo (51): 19,00



30 uds.

LAVABO: SIFONES Y DESAGÜES



34.170.5

Desagüe lavabo con cadenilla de 45 cms. Salida 1 1/4 latón. Pileta Ø 65 mm.

Cromo (51): 8,00

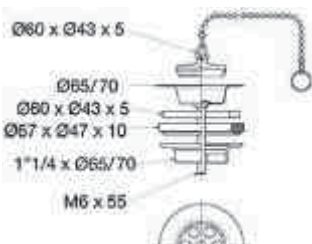

60 uds.

137.040.0

Desagüe lavabo con cadenilla de 45 cms. Salida 1 1/4 latón. Pileta Ø 70 mm.

Cromo (51): 8,00

Bronce (92): 17,00

Oro (52): 21,00



34.620.5

Desagüe lavabo con tapón de goma. Salida universal 1 1/4 latón.

Cromo (51): 5,00

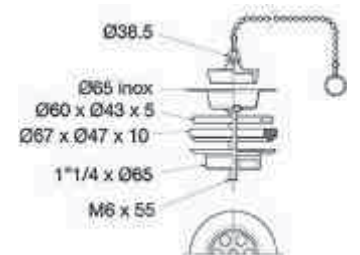

60 uds.



133.435.6

Desagüe fregadero CLICKER tipo basket con rebosadero.

Cromo (51): 18,00

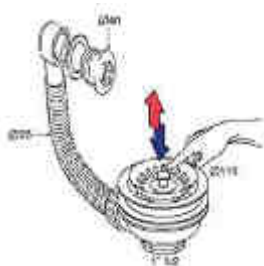

30 uds.



133.535.6

Desagüe fregadero CLICKER tipo basket sin rebosadero.

Cromo (51): 14,00

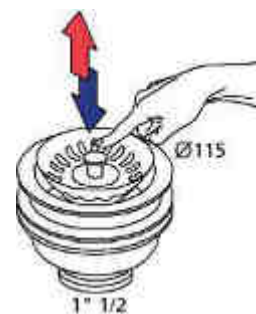

30 uds.



813.343.5

Desagüe fregadero CLICKER LUX con rebosadero y tapa lisa latón.

Cromo (51): 37,00

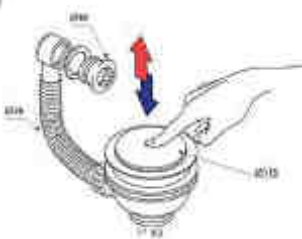

30 uds.



813.353.5

Desagüe fregadero CLICKER LUX con tapa lisa latón.

Cromo (51): 35,00



30 uds.



137.050.5

Desagüe fregadero con cadenilla de 45 cms. de latón. Salida 1"1/2.

Cromo (51): 8,00
 Bronce (92): 18,00
 Plata (90): 18,00
 Oro (52): 21,00

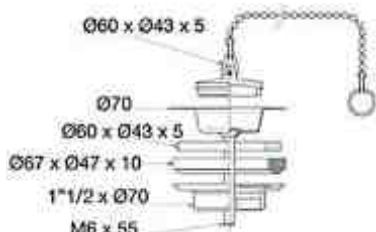

30 uds.



485.309.5

Tubo para lavadora SMART. Extensible 770 a 2200 mm.

Neutro (00): 4,00



100 uds.



SILFRA

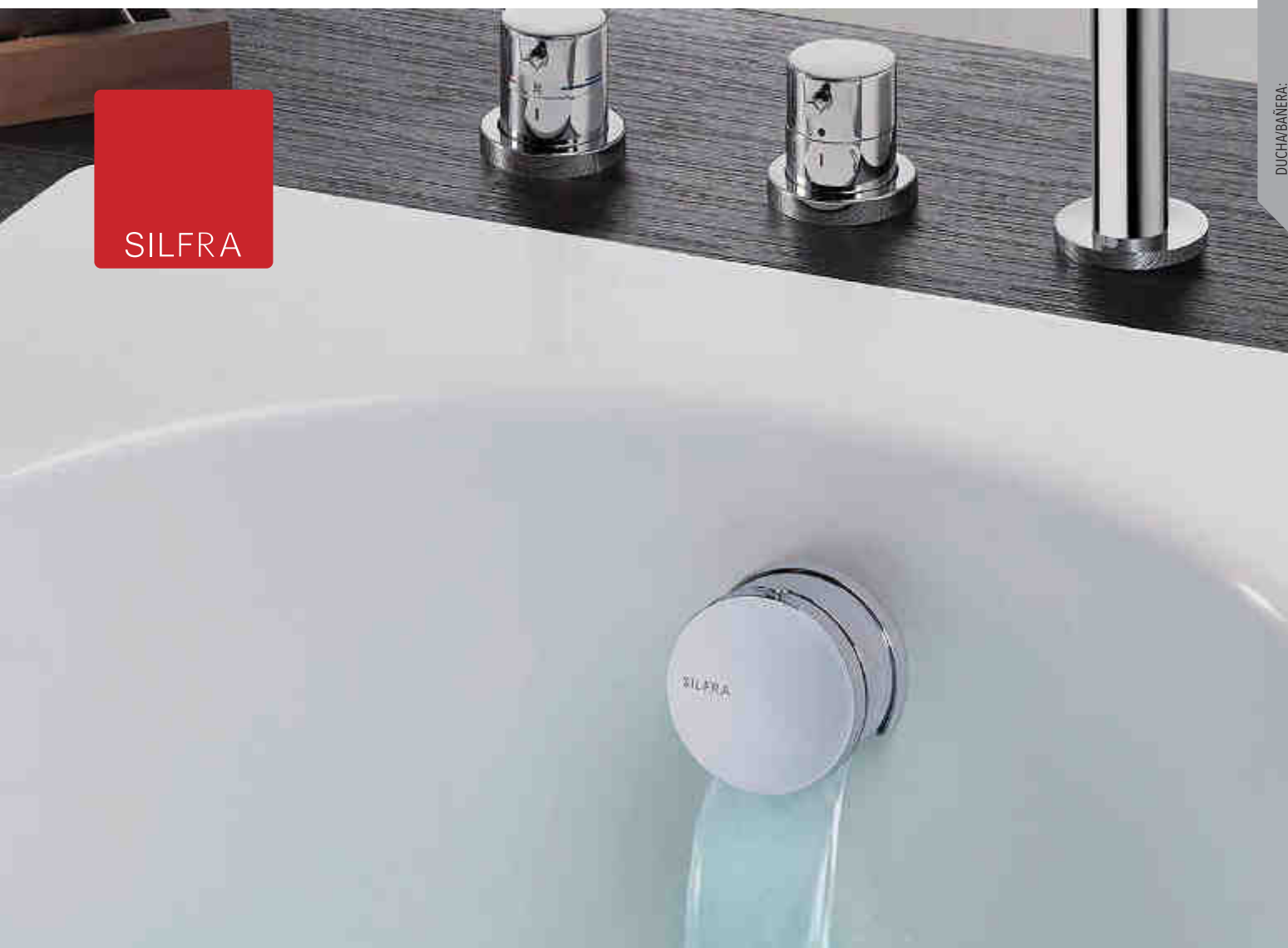



6561.286.6

Válvula diam. 90 mm. 3 tornillos.
Tapa plana latón diam. 110 mm.
Sifón inspeccionable.
Desagua 62 l/min sin sifón.
Desagua 31 l/min con sifón.

● Cromo (51): 39,00
● Negro mate (13): 52,00



60 uds.

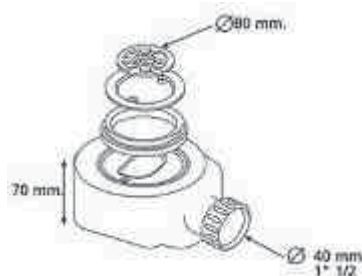

6461.066.6

Válvula diam. 90 mm. 3 tornillos.
Tapa latón diam. 80 mm.
Sifón inspeccionable.
Desagua 62 l/min sin sifón.
Desagua 31 l/min con sifón.

Cromo (51): 39,00



60 uds.

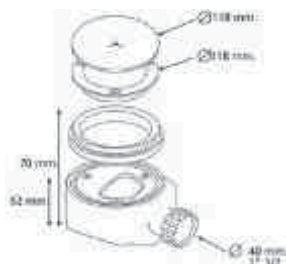

6261.076.6

Válvula diam. 90 mm. 3 tornillos.
Tapa ABS diam. 118 mm.
Altura reducida 62 mm.
Desagua 62 l/min sin sifón.
Desagua 31 l/min con sifón.

Cromo (51): 17,00



60 uds.

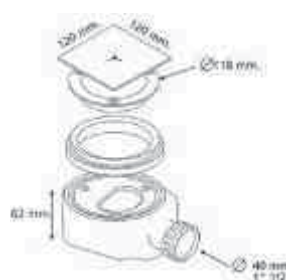

6241.076.6

Válvula diam. 90 mm. 3 tornillos.
Tapa ABS cuadrada 120x120 mm.
Sifón inspeccionable.
Desagua 62 l/min sin sifón.
Desagua 31 l/min con sifón.

Cromo (51): 27,00



60 uds.

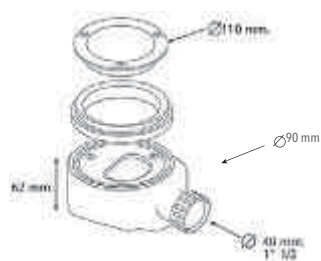

6561.106.6

Válvula diam. 108 mm. 3 tornillos.
Flanja inox AISI 316.
Desagua 62 l/min sin sifón.
Desagua 31 l/min con sifón.

Cromo (51): 17,00



120 uds.



5261.086.6

Válvula diam. 90 mm.
Tapa latón diam. 115 mm. a rosca.
Desagua 62 l/min sin sifón.
Desagua 27 l/min con sifón.

● Cromo (51): 37,00
● Negro mate (13): 52,00
● Blanco (06): 56,00
● Bronce (92): 77,00
● Oro (52): 96,00

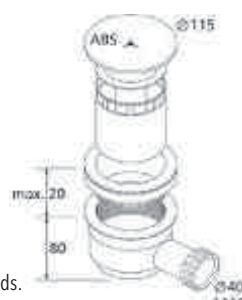

5261.076.6

Válvula diam. 90 mm.
Tapa ABS diam. 115 mm.
Desagua 62 l/min sin sifón.
Desagua 27 l/min con sifón.

● Cromo (51): 17,00
● Blanco (06): 19,00

60 uds.



661.096.6

Válvula diam. 60 mm. 2 tornillos.
Tapa ABS diam. 80 mm.
Sifón inspeccionable.
Desagua 42 l/min sin sifón.
Desagua 24 l/min con sifón.

Cromo (51): 11,00



60 uds.

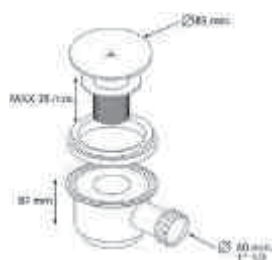

261.086.6

Válvula diam. 60 mm.
Tapa y piletta en latón a rosca.
Desagua 42 l/min.

Cromo (51): 22,00
Blanco (06): 35,00
Bronce (92): 48,00
Oro (52): 60,00



60 uds.



245.096.6

Válvula diam. 60 mm.
Tapa ABS diam. 80 mm. a rosca.
Desagua 36 l/min sin sifón.
Desagua 29 l/min con sifón.

Cromo (51): 8,00



60 uds.

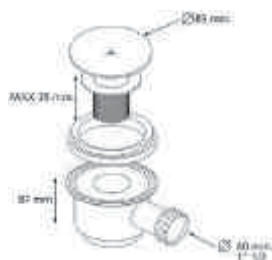

461.096.6

Válvula diam. 60 mm.
Tapa ABS.
Desagua 42 l/min.

Cromo (51): 11,00
Blanco (06): 14,00

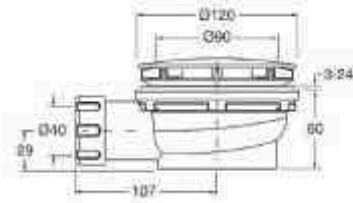

60 uds.

**AD-400**

Válvula con tapa ABS.
Fijación 3 tornillos.
Desagua 62 l/min sin sifón.
Desagua 41 l/min con sifón.

☑ Cromo (51): 24,00
☑ Negro mate (13): 63,00

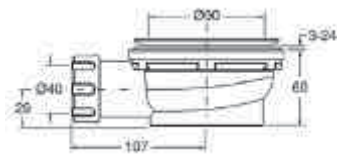

☑ 30 uds.

**AD-420**

Válvula con fijación 3 tornillos.
Desagua 62 l/min sin sifón.
Desagua 41 l/min con sifón.

Cromo (51): 16,00

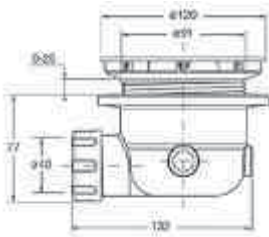

☑ 60 uds.

**AD-880**

Válvula con tapa latón.
Desagua 62 l/min sin sifón.
Desagua 41 l/min con sifón.

Cromo (51): 30,00

☑ 30 uds.

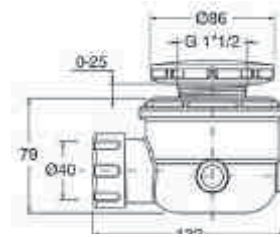
**AD-200**

Válvula con tapa latón diam. 90 mm.
Desagua 27 l/min.

☑ Cromo (51): 18,00
☑ Blanco (06): 18,00

☑ 30 uds.

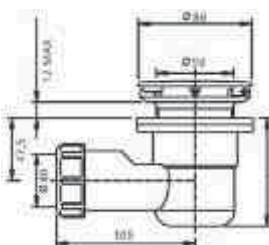
**AD-600**

Válvula con tapa ABS.
Desagua 36 l/min sin sifón.
Desagua 29 l/min con sifón.

Cromo (51): 18,00

☑ 30 uds.

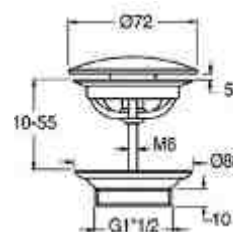
**UD-370S**

Desagüe bañera 1"1/2 UP&DOWN.

Cromo (51): 40,00

☑ 30 uds.





MOD-U2A11

Desagüe bañera UP&DOWN. UNIVERSAL con tubo corrugado de 84 mm. Sifón salvaespacio orientable incorporado.

Cromo (51): 33,00

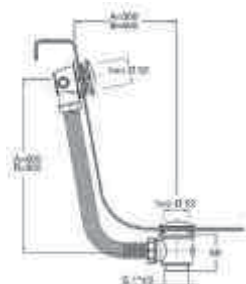

15 uds.



MOD-06122

Desagüe bañera AUTOMÁTICO con cable de 470 mm sin Sifón. Tubo corrugado en PP.

Cromo (51): 39,00
 Negro mate (13): 56,00
 Blanco (06): 59,00
 Bronce (92): 91,00
 Plata (90): 91,00
 Oro (52): 107,00

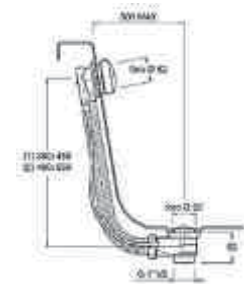

15 uds.



MOD-V1A85

Desagüe exterior para bañera de época con cadenilla. Sifón exterior a suelo. Todo latón.

Cromo (51): 267,00
 Bronce (92): 420,00
 Plata (90): 420,00
 Oro (52): 547,00

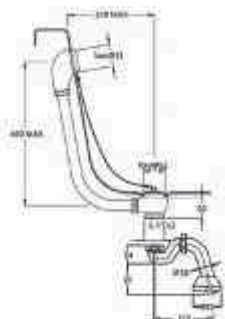

15 uds.

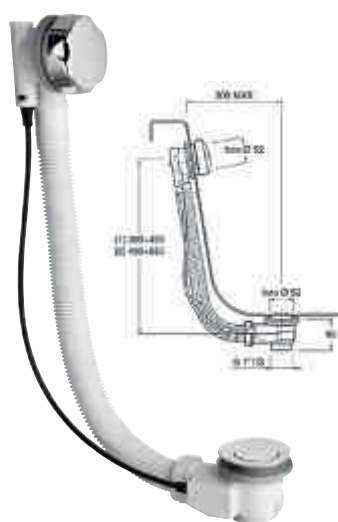

MOD-06222/51

Desagüe AUTOMÁTICO. Cable 570.

Cromo: 43,00

MOD-06322/51

Desagüe AUTOMÁTICO. Cable 670.

Cromo: 45,00

MOD-06422/51

Desagüe AUTOMÁTICO. Cable 770.

Cromo: 50,00

MOD-06522/51

Desagüe AUTOMÁTICO. Cable 900.

Cromo: 51,00

MOD-06622/51

Desagüe AUTOMÁTICO. Cable 1000.

Cromo: 53,00

15 uds.



MOD-V1U29

Desagüe exterior para bañera de época con accionamiento a presión UP&DOWN. Sifón exterior a suelo.

Cromo (51): 301,00

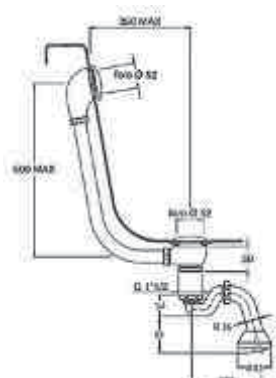

15 uds.



MOD-D6216

Desagüe AUTOMÁTICO con entrada de agua y codo 90°. Válvula anti-retorno. Cable 570 mm. Tubo corrugado de PP. Con llenado tipo cascada.

Cromo (51): 99,00

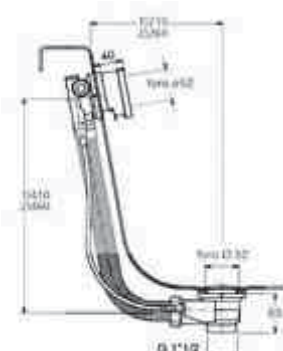

15 uds.

**AS-266S**

Desagüe bañera UP&DOWN sin rebosadero para colocar tapón de su producción.

Cromo (51): 41,00

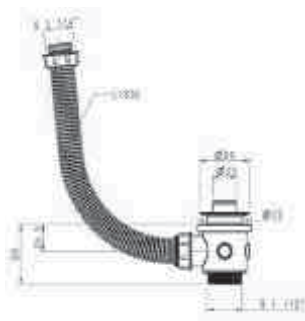

 20 uds.

**MOD-U31**

Desagüe bañera UP&DOWN con rebosadero escondido para colocar tapón de su producción.

Cromo (51): 102,00

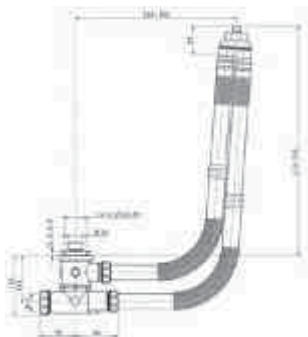

 20 uds.

**AS-370S**

Desagüe bañera UP&DOWN con tubo corrugado y mecanismo para colocar su tapón + Sifón AS073.

Cromo (51): 45,00

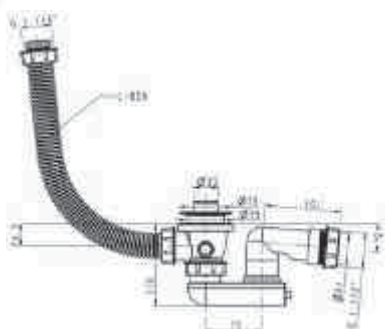

 20 uds.

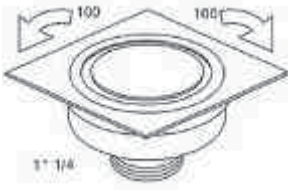

62.405.5
Sumidero 100x100 mm.
Salida vertical.

■ Cromo (51): 15,00
■ Bronce (92): 30,00



30 uds.

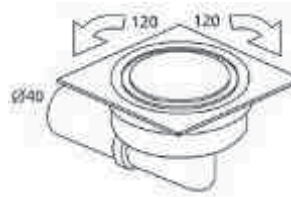

65.409.6
Sumidero 120x120 mm.
Salida horizontal.

■ Cromo (51): 17,00
■ Bronce (92): 33,00



30 uds.

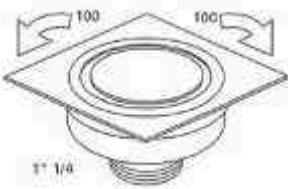

62.455.5
Sumidero LUX 100x100 mm.
Tapa lisa, salida vertical.

Cromo (51): 31,00



30 uds.

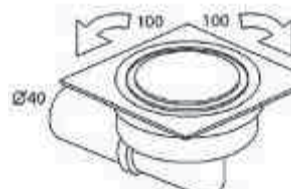

62.450.6
Sumidero LUX 100x100 mm.
Tapa lisa, salida horizontal.

Cromo (51): 42,00



30 uds.



2562.521.8
Sumidero vertical KUALA LUMPUR
120x120 mm. Sifón extraíble.

Cromo (51): 55,00



30 uds.



2565.521.8
Sumidero horizontal KUALA
LUMPUR 120x120 mm. Sifón
extraíble.

Cromo (51): 55,00



30 uds.

**AL-2000R**

Recubrimiento azulejos con rejilla de ventilación, especial hidromasaje. Peso máximo 12 Kg.

Blanco (02): 95,00

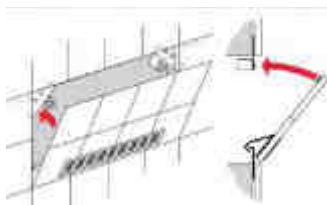
**CONTENIDO DEL KIT**

- 2 Ángulos de junta con imanes regulables.
- 2 Plaquitas de contacto.
- 2 Dispositivos enganche con seguro apertura.
- 2 Placas de soporte de aluminio (80x300 mm).
- 1 Rejilla de ventilación (80x300 mm).
- 1 Cordón para abrir.
- 1 Tubo de pegamento de silicona.
- Instrucciones de montaje.

 30 uds.

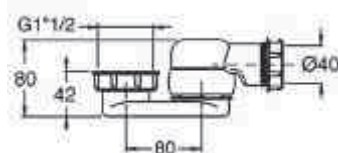
**AS-078**

Sifón PeH espesor mínimo orientable con tuerca.

Neutro (00): 9,00



 60 uds.

**AL-2000**

Recubrimiento azulejos con capacidad de registro desde 15x15 cms. hasta 50x100 cms. Peso máximo 12 Kg.

Neutro (00): 40,00

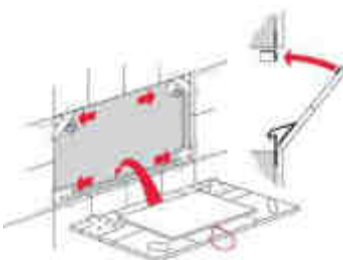
**CONTENIDO DEL KIT**

- 2 Ángulos de junta con imanes regulables.
- 2 Plaquitas de contacto.
- 2 Dispositivos enganche con seguro apertura.
- 1 Cordón para abrir.
- 1 Tubo de pegamento de silicona.
- Instrucciones de montaje.

 30 uds.

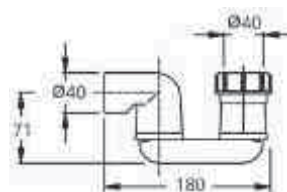
**AS-073**

Sifón PeH orientable con tuerca 1"1/2.

Neutro (00): 8,00



 60 uds.

**AL-VERMAG**

Recubrimiento azulejos con capacidad de registro desde 15x15 cms. hasta 30x30 cms. Peso máximo 10 Kg.

Neutro (00): 27,00

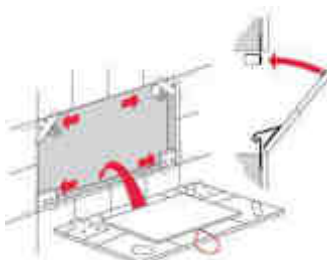

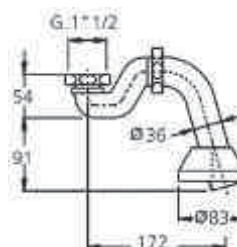

**CONTENIDO DEL KIT**

- 4 Ángulos de junta con imanes regulables.
- 4 Plaquitas de contacto.
- 1 Cordón para abrir.
- Instrucciones de montaje.

 30 uds.

**AS-050**

Sifón latón a suelo.

 Cromo (51): 79,00
 Bronce (92): 152,00
 Plata (90): 152,00
 Oro (52): 192,00





RI-038

Tapón diam. 72 mm. en ABS.

Cromo (51): 9,00



ACOM 65

Junta doble bilabial para válvula plato ducha.

Neutro (00): 2,00

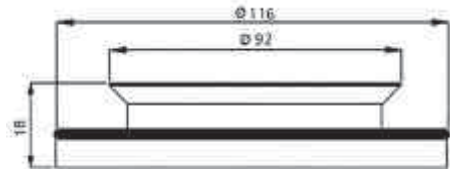

RI-005

Tapón diam. 42 mm. en latón.

- Cromo (51): 6,00
- Blanco (06): 11,00
- Bronce (92): 12,00
- Plata (90): 12,00
- Oro (52): 18,00
- Niquel (85): 12,00

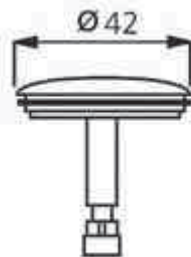

RI-085

Kit de sustitución UP&DOWN para bañera.

Cromo (51): 40,00

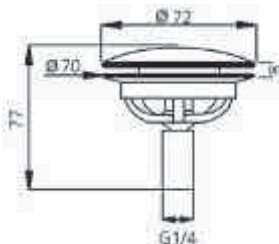

NOTA:

Sirve para sustituir desagües automáticos por el nuevo sistema UP&DOWN. Permite la sustitución sin necesidad de desmontar ninguna pieza interior, sólo cambiando pileta, tapón y tornillo. Útil para reparaciones o sustitución de sistema.



983.401.8

Desagüe horizontal en ABS para ducha a pavimento adaptable de 400 a 1200 mm.

Cromo (51): 420,00



15 uds.

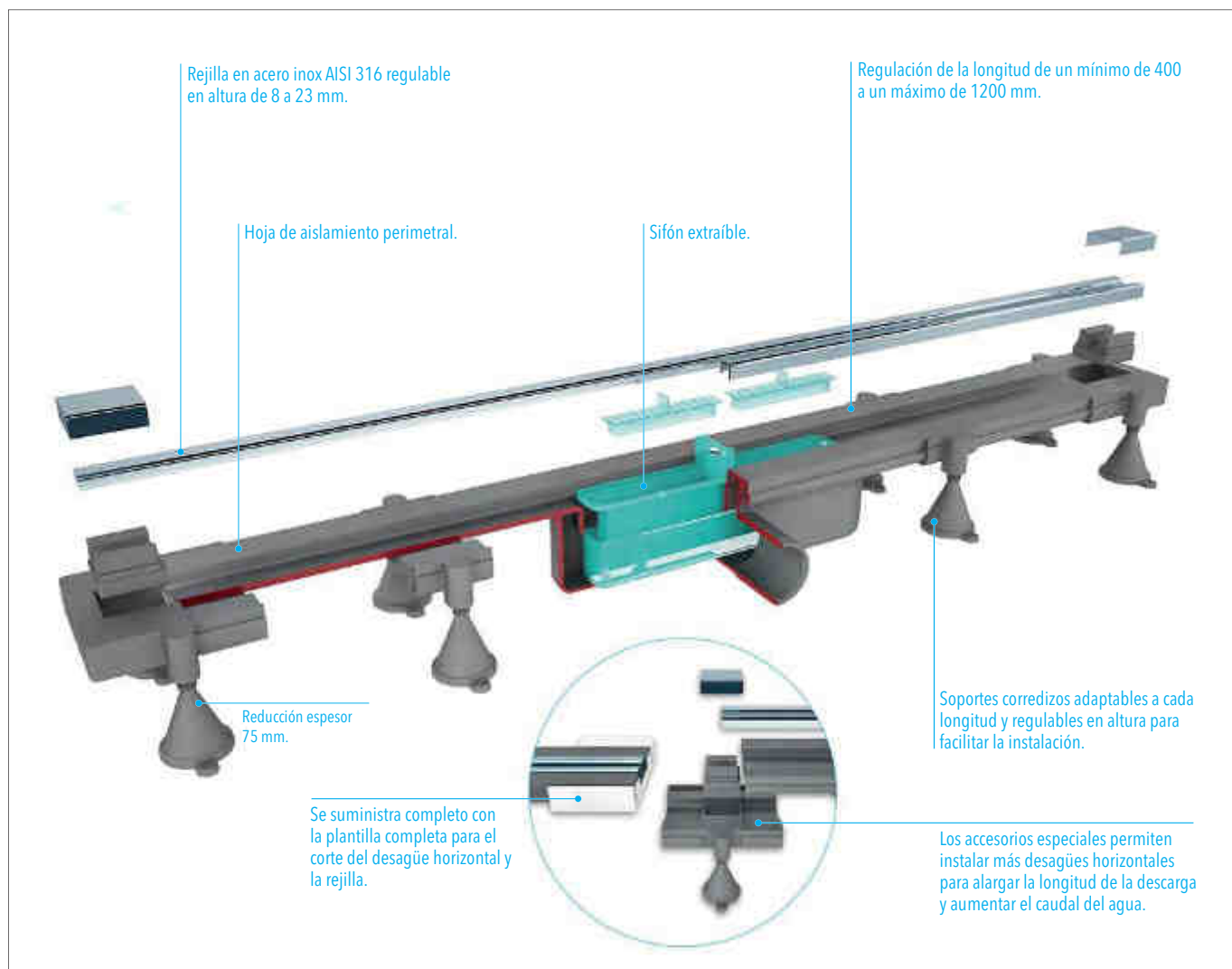
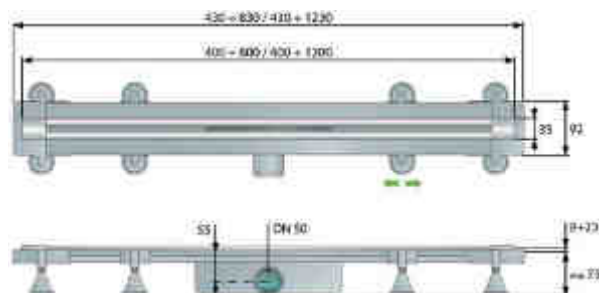

973.201.8

Desagüe horizontal DEFLOW con rejilla de 800 mm.

Inox satinado (19): 366,00

15 uds.

973.401.8

Desagüe horizontal DEFLOW con rejilla de 1000 mm.

Inox satinado (19): 418,00

15 uds.

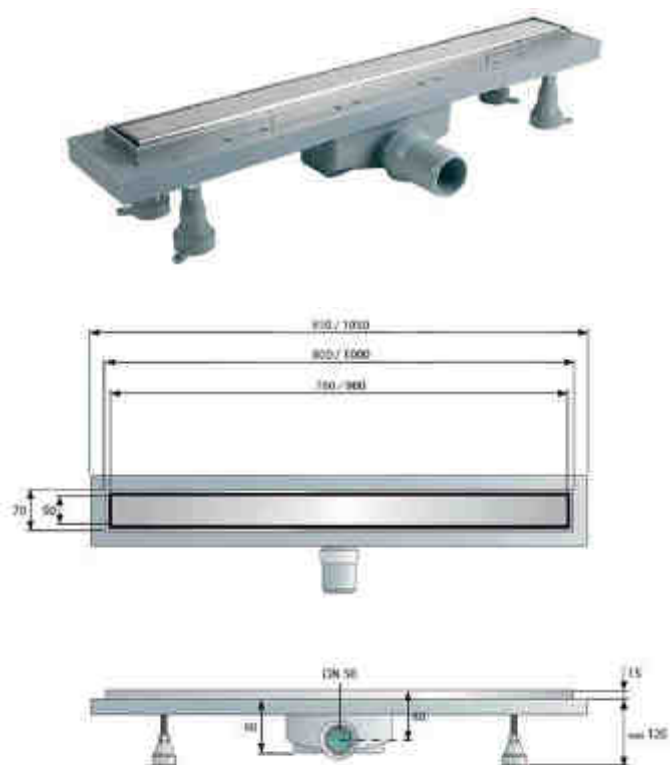

972.101.8

Desagüe quadro DEFLOW con rejilla de 300x300 mm.

Inox satinado (19): 345,00

15 uds.

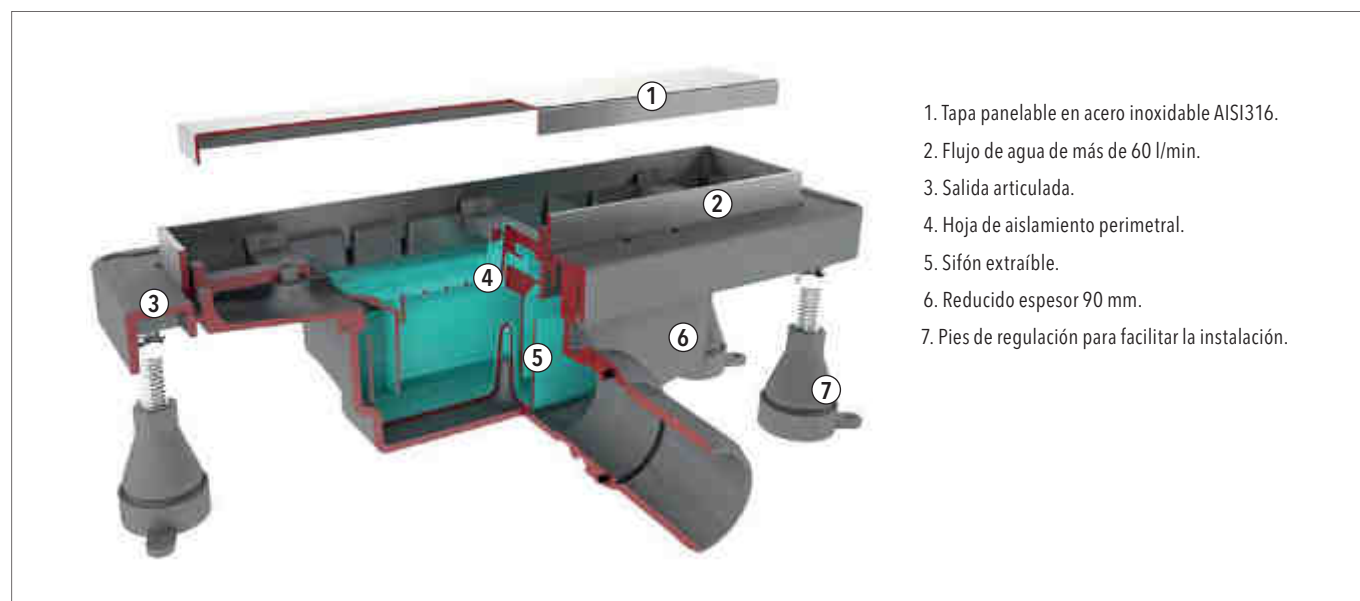

1. Tapa panelable en acero inoxidable AISI316.
2. Flujo de agua de más de 60 l/min.
3. Salida articulada.
4. Hoja de aislamiento perimetral.
5. Sifón extraíble.
6. Reducido espesor 90 mm.
7. Pies de regulación para facilitar la instalación.

943.906.8C

Desagüe horizontal BASICFLOW con rejilla cubre perfil de 700 mm.

Cuadrada (21): 192,00



15 uds.

943.904.8C

Desagüe horizontal BASICFLOW con rejilla cubre perfil de 700 mm.

Línea (23): 192,00



15 uds.

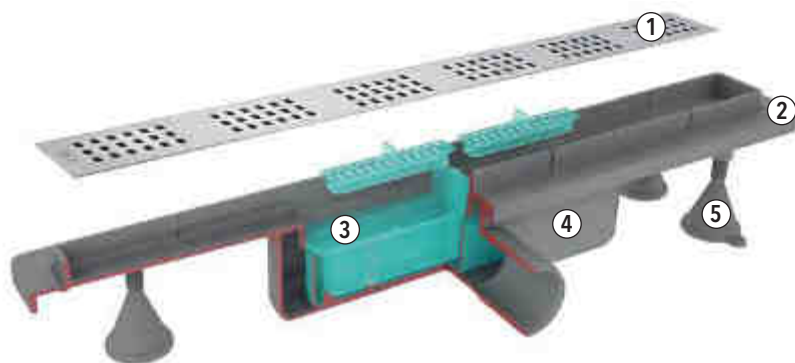
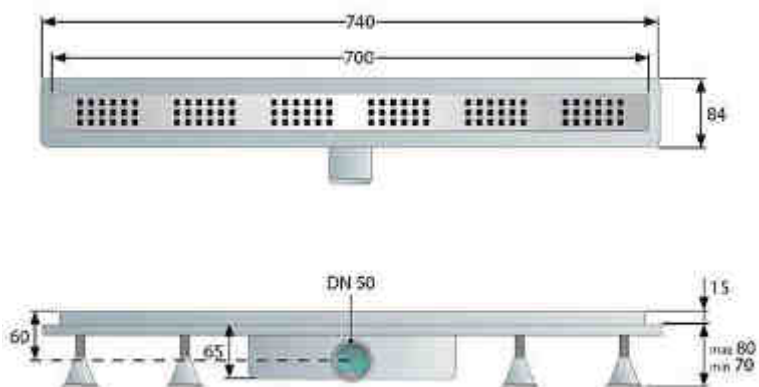

1. Rejilla en acero inoxidable AISI316.
2. Hoja de aislamiento perimetral.
3. Sifón extraíble.
4. Reducido espesor 70 mm.
5. Pies de regulación para facilitar la instalación.



rejilla que cubre el borde de plástico



971.101.8

DEFLOW Q+Q. Desagüe plato de ducha de obra con Tejido Técnico impermeable. Rejilla 100x100 mm. Tela de 50x50 cms.

	Cromo (51):	42,00
	Diana (24):	42,00
	Raya (22):	42,00
	Superficie (30):	64,00

NOTA: En caso de no especificar embellecedor, entenderemos rejilla estándar CROMO.

971.121.8

DEFLOW Q+Q. Desagüe plato de ducha de obra con Tejido Técnico impermeable. Rejilla 100x100 mm. Tela de 150x120 cms.

	Cromo (51):	65,00
	Diana (24):	65,00
	Raya (22):	65,00
	Superficie (30):	86,00

NOTA: En caso de no especificar embellecedor, entenderemos rejilla estándar CROMO.

971.131.8

DEFLOW Q+Q. Desagüe plato de ducha de obra con Tejido Técnico impermeable. Rejilla 100x100 mm. Tela de 150x250 cms.

	Cromo (51):	71,00
	Diana (24):	71,00
	Raya (22):	71,00
	Superficie (30):	93,00

NOTA: En caso de no especificar embellecedor, entenderemos rejilla estándar CROMO.

971.141.8

DEFLOW Q+Q (especial para sustitución bañeras). Desagüe plato de ducha de obra con Tejido Técnico impermeable. Rejilla 100x100 mm. Tela de 180x150 cms.

	Cromo (51):	68,00
	Diana (24):	68,00
	Raya (22):	68,00
	Superficie (30):	89,00

NOTA: En caso de no especificar embellecedor, entenderemos rejilla estándar CROMO.

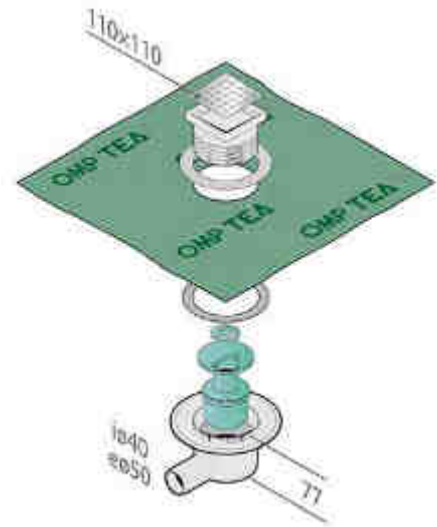

15 uds.



963.111.8

DEFLOW SKIPPER HORIZONTAL. Bote sifónico para platos de ducha de obra con Tejido Técnico impermeable. Rejilla lineal INOX de 700 mm. Tela de **100x50 cms.**

Onda (51):	104,00
Línea (23):	104,00
Raya (22):	104,00
Oblicua (25):	104,00
Cuadrada (21):	104,00

NOTA: En caso de no especificar embellecedor, entenderemos rejilla estándar CUADRADA.

963.121.8

DEFLOW SKIPPER HORIZONTAL. Bote sifónico para platos de ducha de obra con Tejido Técnico impermeable. Rejilla lineal INOX de 700 mm. Tela de **150x120 cms.**

Onda (51):	166,00
Línea (23):	166,00
Raya (22):	166,00
Oblicua (25):	166,00
Cuadrada (21):	166,00

NOTA: En caso de no especificar embellecedor, entenderemos rejilla estándar CUADRADA.



963.131.8

DEFLOW SKIPPER HORIZONTAL. Bote sifónico para platos de ducha de obra con Tejido Técnico impermeable. Rejilla lineal INOX de 700 mm. Tela de **250x150 cms.**

Onda (51):	193,00
Línea (23):	193,00
Raya (22):	193,00
Oblicua (25):	193,00
Cuadrada (21):	193,00

NOTA: En caso de no especificar embellecedor, entenderemos rejilla estándar CUADRADA.

963.141.8

DEFLOW SKIPPER HORIZONTAL (especial para sustitución bañeras). Bote sifónico para platos de ducha de obra con Tejido Técnico impermeable. Rejilla lineal INOX de 700 mm. Tela de **180x150 cms.**

Onda (51):	176,00
Línea (23):	176,00
Raya (22):	176,00
Oblicua (25):	176,00
Cuadrada (21):	176,00

NOTA: En caso de no especificar embellecedor, entenderemos rejilla estándar CUADRADA.

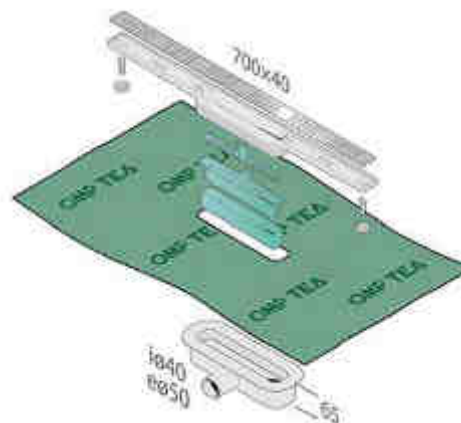

15 uds.

971.831.8

DEFLOW Q+Q. Desagüe plato de ducha de obra con Tejido Técnico impermeable. Rejilla de 100x100 mm. Tela de 150x250 cms.

- Cromo (51): 69,00
- Diana (24): 69,00
- Raya (22): 69,00
- Superficie (30): 69,00

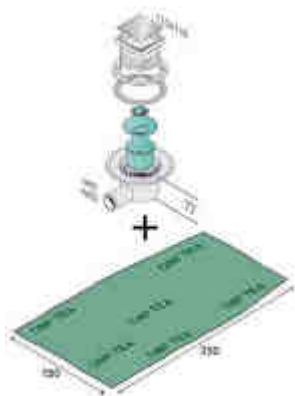

30 uds.

2665.491.8

Descompuesto TIRANA. Rejilla regulable en altura de 15 a 30 mm. Sifón extraíble e inspeccionable. Con cierre hidráulico 35 mm. y desagua 17 l/min. Tapa latón. La tela de 150x250 cms. se entrega por separado.

Cromo (51): 131,00

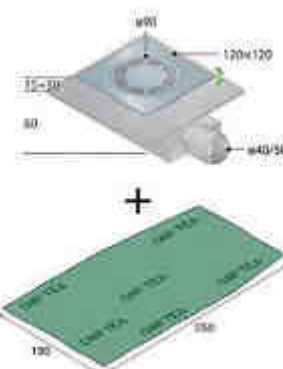

30 uds.

TIRANA EVO AISI316

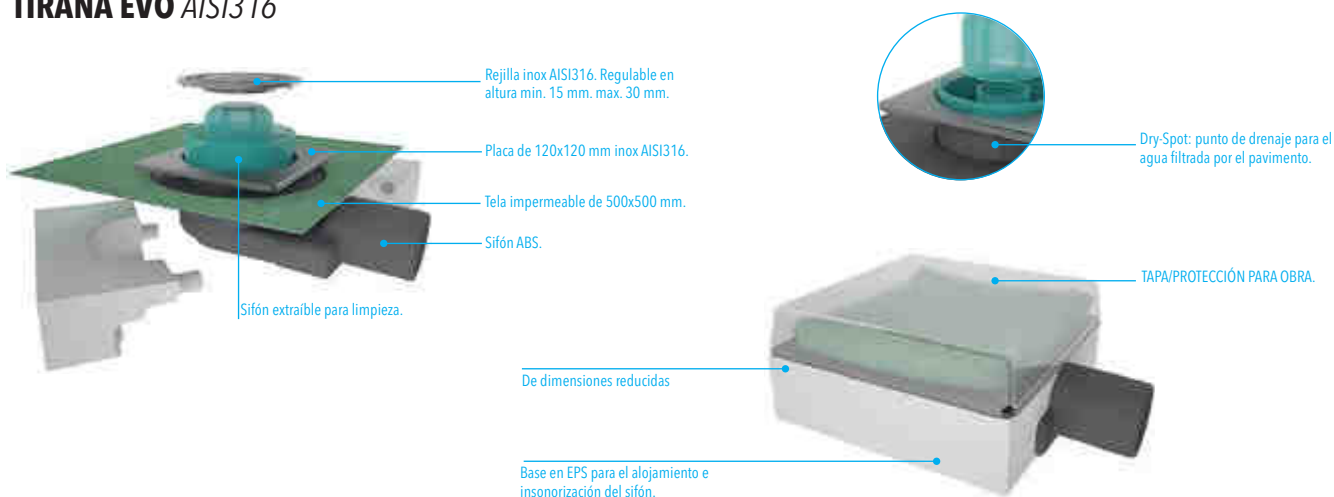

2755.405.8

TIRANA EVO DESIGN. Desagüe plato de ducha de obra con Tejido Técnico impermeable. Rejilla diam. 90 mm. Tela de 50x50 cms.

Cromo (51): 95,00



30 uds.



271.111.8

Bote sifónico para platos de ducha de obra con tela de PVC impermeable. Rejilla diam. 130 mm. Tela de **50x50 cms.**

✳ Cromo (51):	35,00
⊕ Class (26):	44,00
⊗ Diana (24):	55,00

NOTA: En caso de no especificar embellecedor, entenderemos rejilla estándar CROMO.

271.121.8

Bote sifónico para platos de ducha de obra con tela de PVC impermeable. Rejilla diam. 130 mm. Tela de **120x120 cms.**

✳ Cromo (51):	42,00
⊕ Class (26):	51,00
⊗ Diana (24):	62,00

NOTA: En caso de no especificar embellecedor, entenderemos rejilla estándar CROMO.

271.141.8

Bote sifónico para platos de ducha de obra con tela de PVC impermeable. Rejilla diam. 130 mm. Tela de **180x120 cms.** (especial para sustitución bañeras).

✳ Cromo (51):	61,00
⊕ Class (26):	69,00
⊗ Diana (24):	80,00

NOTA: En caso de no especificar embellecedor, entenderemos rejilla estándar CROMO.

271.181.8

Bote sifónico para platos de ducha de obra con tela de PVC impermeable. Rejilla diam. 130 mm. Tela de **180x200 cms.**

✳ Cromo (51):	74,00
⊕ Class (26):	84,00
⊗ Diana (24):	95,00

NOTA: En caso de no especificar embellecedor, entenderemos rejilla estándar CROMO.

271.131.8

Bote sifónico para platos de ducha de obra con tela de PVC impermeable. Rejilla diam. 130 mm. Tela de **180x250 cms.**

✳ Cromo (51):	77,00
⊕ Class (26):	87,00
⊗ Diana (24):	98,00

NOTA: En caso de no especificar embellecedor, entenderemos rejilla estándar CROMO.

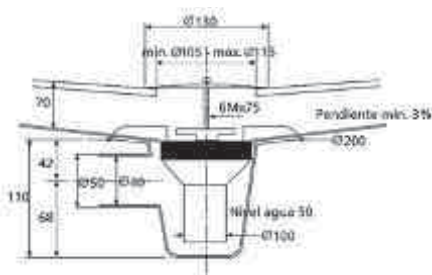

15 uds.

**471.111.8**

Bote sifónico para platos de ducha de obra con tela de PVC impermeable. Rejilla de 100x100 mm. Tela de **50x50 cms.**

Cromo (51):	49,00
Diana (24):	49,00
Raya (22):	49,00
Superficie (30):	71,00

NOTA: En caso de no especificar embellecedor, entenderemos rejilla estándar CROMO.

471.121.8

Bote sifónico para platos de ducha de obra con tela de PVC impermeable. Rejilla de 100x100 mm. Tela de **120x120 cms.**

Cromo (51):	58,00
Diana (24):	58,00
Raya (22):	58,00
Superficie (30):	81,00

NOTA: En caso de no especificar embellecedor, entenderemos rejilla estándar CROMO.

471.141.8

Bote sifónico para platos de ducha de obra con tela de PVC impermeable. Rejilla de 100x100 mm. Tela de **180x120 cms.**

Cromo (51):	73,00
Diana (24):	73,00
Raya (22):	73,00
Superficie (30):	95,00

NOTA: En caso de no especificar embellecedor, entenderemos rejilla estándar CROMO.

471.181.8

Bote sifónico para platos de ducha de obra con tela de PVC impermeable. Rejilla de 100x100 mm. Tela de **180x200 cms.**

Cromo (51):	87,00
Diana (24):	87,00
Raya (22):	87,00
Superficie (30):	110,00

NOTA: En caso de no especificar embellecedor, entenderemos rejilla estándar CROMO.

471.131.8

Bote sifónico para platos de ducha de obra con tela de PVC impermeable. Rejilla de 100x100 mm. Tela de **180x250 cms.**

Cromo (51):	106,00
Diana (24):	106,00
Raya (22):	106,00
Superficie (30):	132,00

NOTA: En caso de no especificar embellecedor, entenderemos rejilla estándar CROMO.

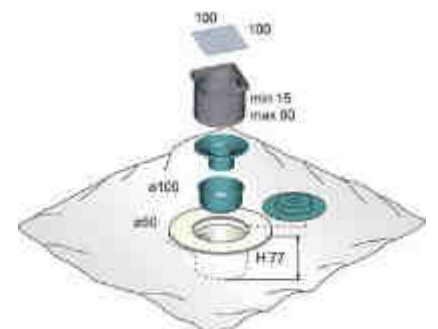

15 uds.

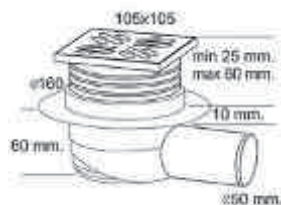

265.241.8

GULLY PERFIL BAJO.
Bote sifónico para platos de ducha de obra con tela de PVC impermeable. Rejilla INOX de 100x100 mm. Tela de 120x150 cms.

Cromo (51): 59,00



15 uds.



263.241.8

GULLY INFERIOR.
Bote sifónico para platos de ducha de obra con tela de PVC impermeable. Rejilla INOX de 100x100 mm. Tela de 120x150 cms.

Cromo (51): 59,00



15 uds.

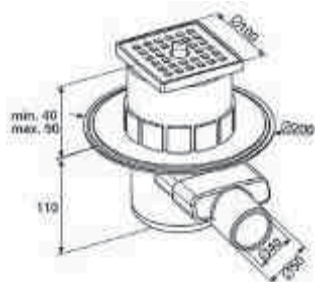

575.131.8

GULLY NO LIMITS.
Bote sifónico para BAÑERA DE OBRA.
Rejilla INOX de 100x100 mm. Tela de PVC impermeable de 250x180 cms.

Cromo (51): 211,00



575.631.8

GULLY NO LIMITS.
Bote sifónico para BAÑERA DE OBRA CON REBOSADERO.
Rejilla INOX de 100x100 mm. Tela de PVC impermeable de 250x180 cms.

Cromo (51): 260,00

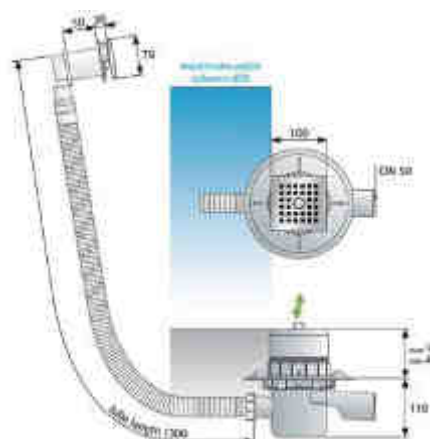

**979.X42.0**

Rollo de Tejido Técnico.
Aislante para impermeabilizar.

979.142.0 (1,50x1m):	22,00
979.242.0 (1,50x2m):	44,00
979.342.0 (1,50x3m):	66,00
979.XXXX (1,50x20m):	441,00

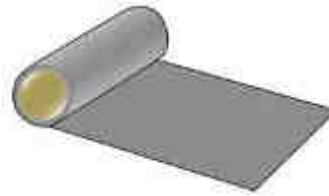
**871.142.0**

Rollo de tela PVC de 1,8x2m.
Aislante para impermeabilizar.

Neutro (00):	36,00
--------------	-------

(unidad de venta metro lineal)



NOTA: Al solapar una tela con la otra, hacer el sellado sin peligro de pérdidas siguiendo la dirección del agua.

972.800.0

Kit accesorios de Tejido Técnico compuesto de 4 esquineros cerrados y 2 abiertos para facilitar la instalación en los puntos de mayor dificultad.

Neutro (00):	81,00
--------------	-------

979.600.5

Pieza de tela DEFLOW para toma de agua de 110 mm de diam. exterior y 18 mm de diam. interior.
Se fija a la tela con cola para DEFLOW 979.850.0.

Neutro (00):	7,00
--------------	------

**979.811.0**

Adhesivo doble cara elastoplástico. 15 m. de rollo (50 mm ancho x 1 mm espesor). Para sellar paredes.

Neutro (00):	42,00
--------------	-------

**979.850.5**

Cola 5 kg para DEFLOW.

Neutro (00):	94,00
--------------	-------

**177.100.0**

Bolsa completa de complementos GULLY.

Neutro (00):	11,00
--------------	-------

77.100.0

Solo rejilla GULLY.

Cromo (51):	6,00
Bronce (92):	21,00
Oro (52):	21,00



Fluidmaster



T05-2116

Cisterna empotrar 8 cms. con estructura a pavimento.

T05-2116: 138,00



 10 uds.

esquema pág. 125

T06-5113

Cisterna empotrar bajo ventana con estructura.

T06-5113: 182,00



 5 uds.

esquema pág. 125

T05-0130

Cisterna empotrar obra 8 cms. sin estructura.

T05-0130: 86,00



 10 uds.

esquema pág. 125

F2-0053

Estructura bidé suspendido.

F2-0053: 126,00



 5 uds.

esquema pág. 125

P57-0120

Doble pulsador ABS CROMO.

P57-0120: 34,00

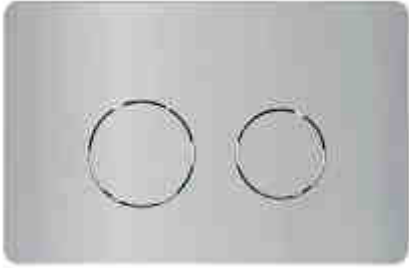

esquema pág. 126

P57-0018

Doble pulsador ACERO INOX AISI 316

P57-0018: 105,00

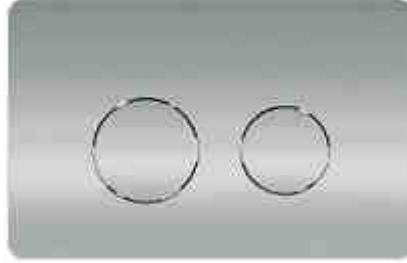

esquema pág. 126

P57-0110

Doble pulsador ABS CROMO SATINADO.

P57-0110: 34,00

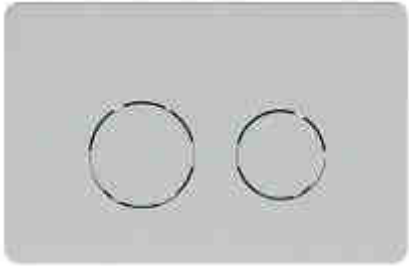

esquema pág. 126

P57-0130

Doble pulsador ABS BLANCO.

P57-0130: 20,00



esquema pág. 126

P43-0120

Doble pulsador ABS CROMO.

P43-0120: 34,00

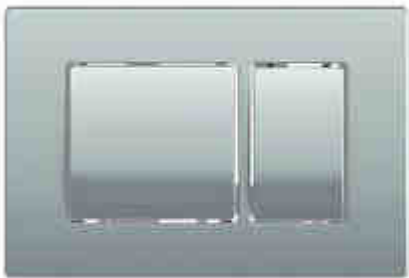

esquema pág. 126

P43-0130

Doble pulsador ABS BLANCO.

P43-0130: 20,00

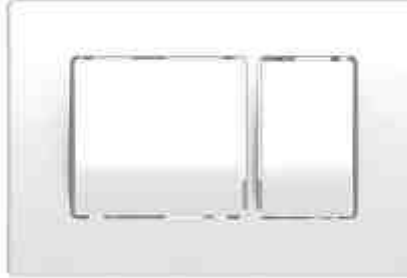

esquema pág. 126

P40-0110

Doble pulsador ABS CROMO SATINADO.

P40-0110: 36,00



esquema pág. 126

P40-0190

Doble pulsador ABS NEGRO MATE.

P40-0190: 50,00



esquema pág. 126

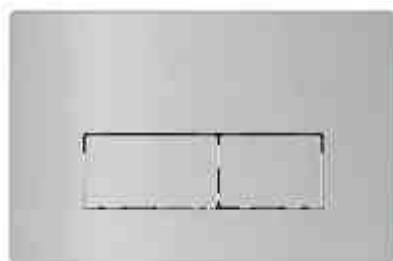

P58-0120

Doble pulsador ABS CROMO.

P58-0120: 36,00

esquema pág. 126

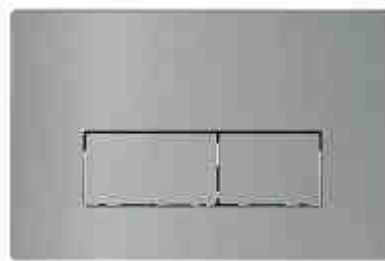

P58-0018

Doble pulsador ACERO INOX SATINADO.

P58-0018: 36,00

esquema pág. 126

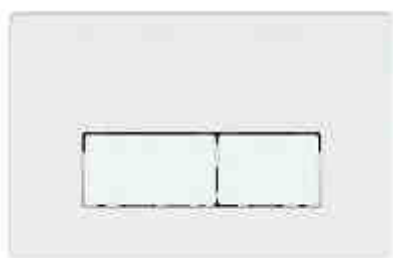

P58-0130

Doble pulsador ABS BLANCO.

P58-0130: 22,00

esquema pág. 126



P58-0190

Doble pulsador ABS NEGRO MATE.

P58-0190: 50,00

esquema pág. 126

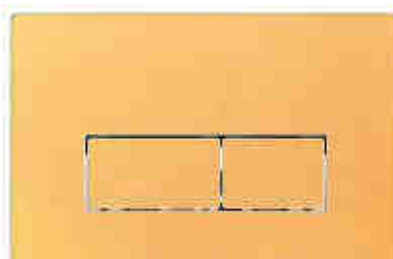

P58-0180

Doble pulsador ORO.

P58-0180: 176,00

esquema pág. 126



P58-0181

Doble pulsador CROMO NEGRO.

P58-0181: 150,00

esquema pág. 126

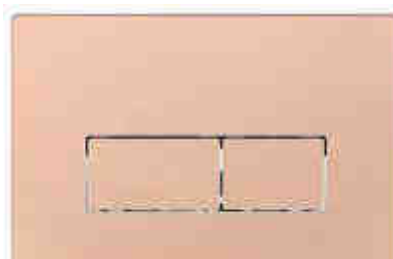

P58-0182

Doble pulsador ORO ROSA.

P58-0182: 180,00

esquema pág. 126

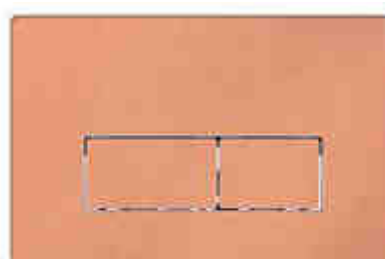

P58-0183

Doble pulsador ORO ROSA SATINADO.

P58-0183: 160,00

esquema pág. 126



P58-0184

Doble pulsador BRONCE.

P58-0184: 170,00

esquema pág. 126

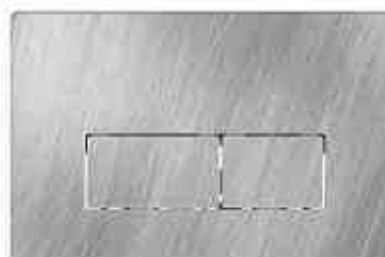

P58-0185

Doble pulsador PLATA.

P58-0185: 170,00

esquema pág. 126

T05-2116

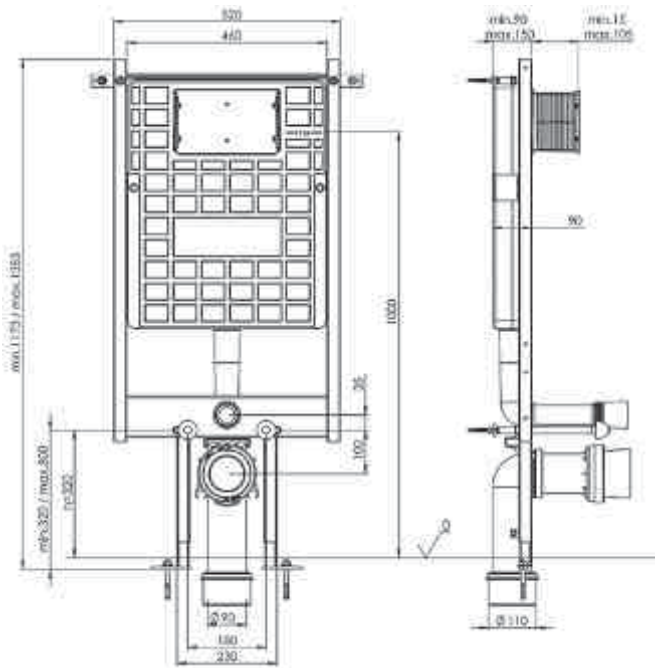

T06-5113

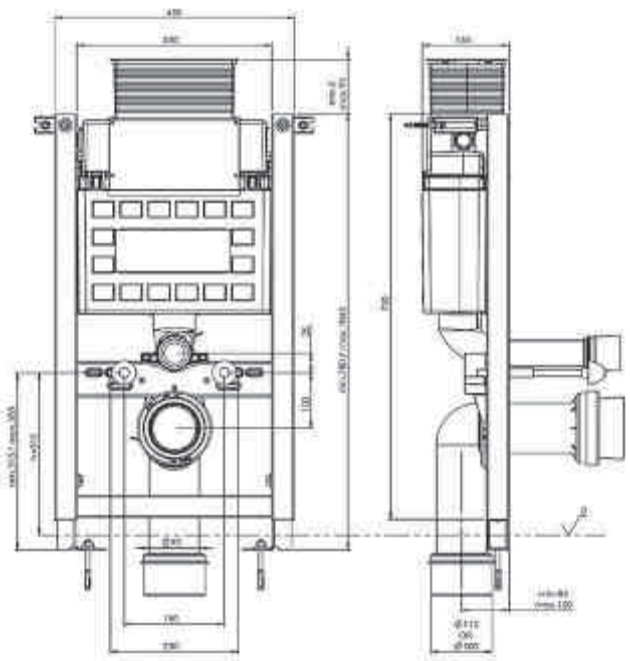

T05-0130

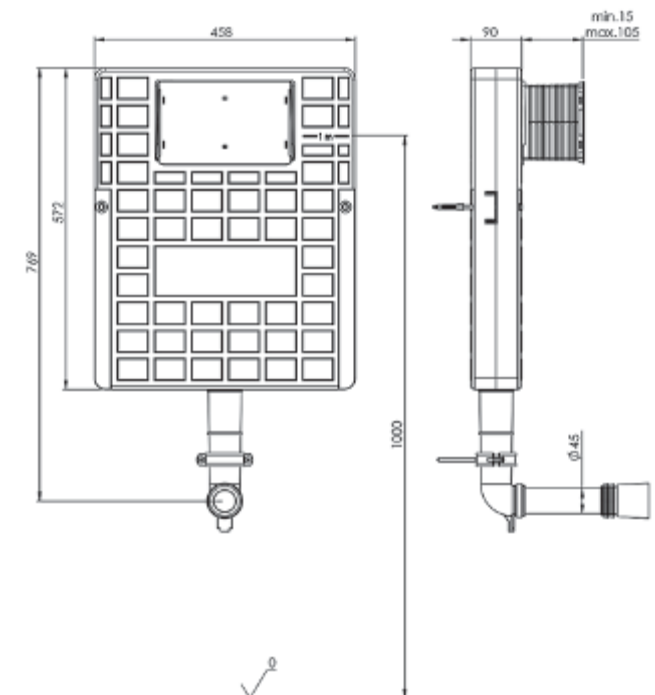

F2-0053

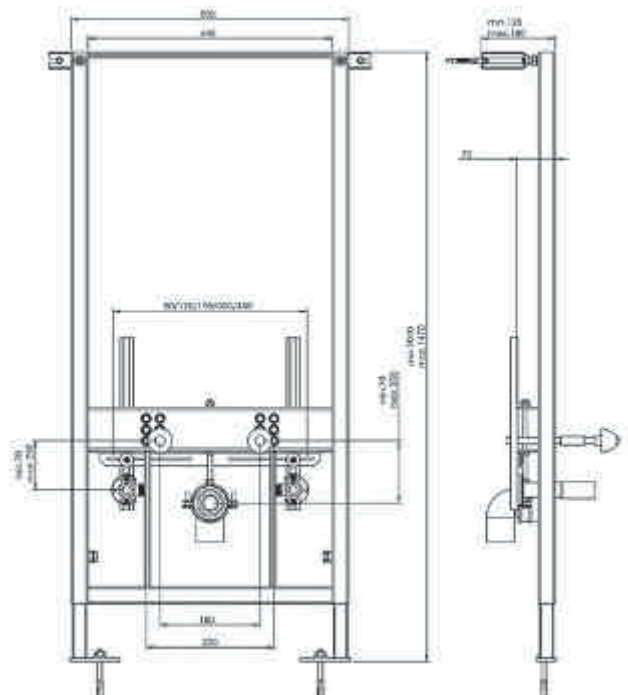

P57-0120
 P57-0110
 P57-0018
 P57-0130

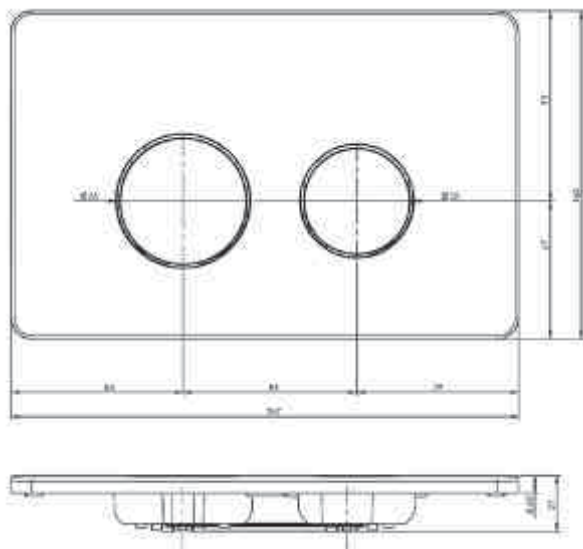

P43-0120
 P43-0130

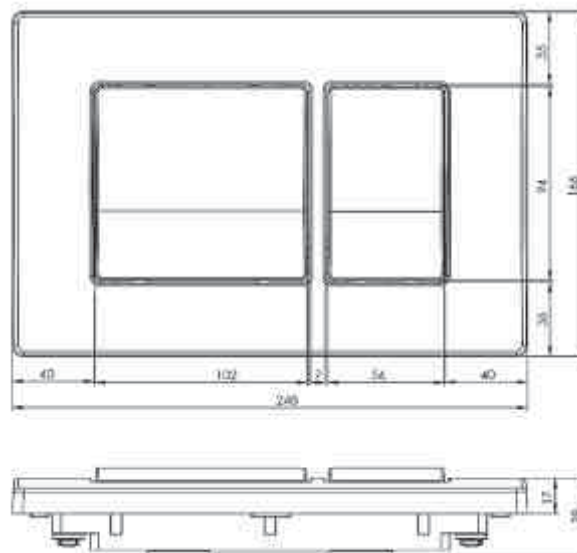

P40-0110
 P40-0190

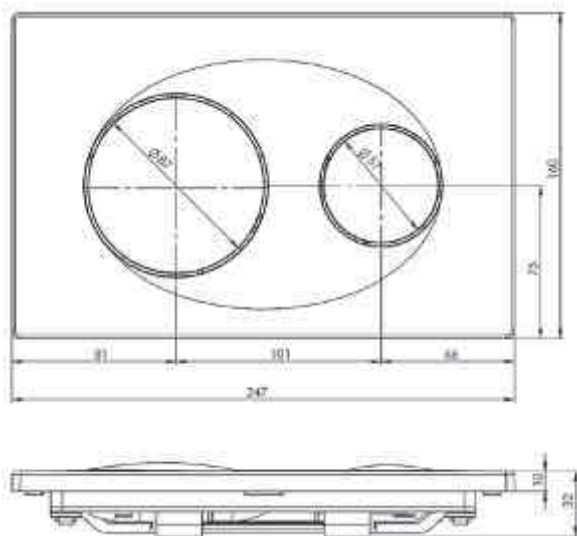

P58-0120
 P58-0130
 P58-0018
 P58-0190
 P58-0180

P58-0181
 P58-0182
 P58-0083
 P58-0184
 P58-0185

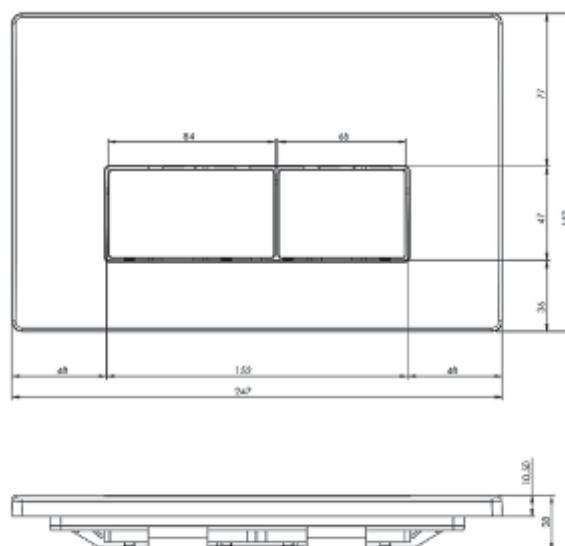



747-E

Flotador lateral silencioso con entrada 3/8" M con rosca latón y filtro de entrada.

Neutro (00): 13,25

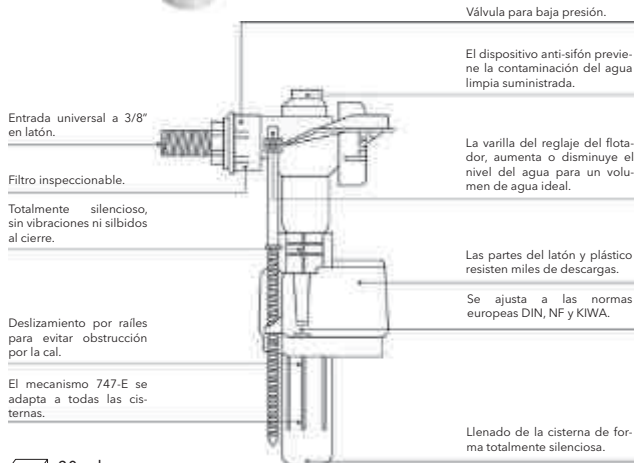

20 uds.



407-E

Flotador telescópico inferior con regulador de presión con rosca latón. Entrada 3/8" M.

Neutro (00): 12,25

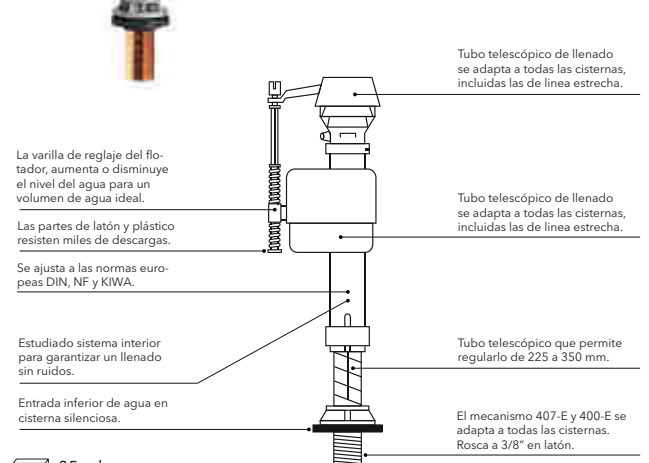

25 uds.



400-E

Flotador telescópico inferior con regulador de presión con rosca PVC. Entrada 3/8" M.

Neutro (00): 10,75

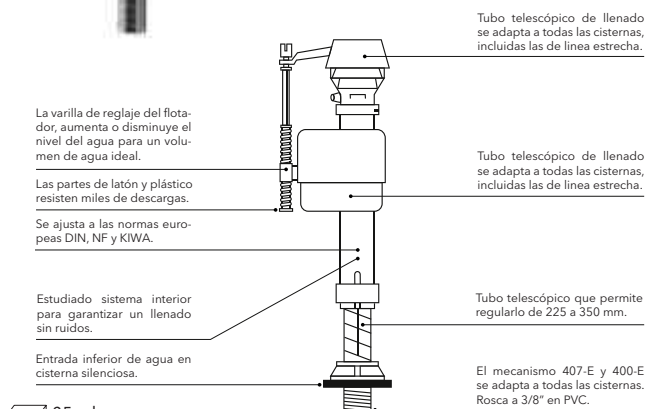

25 uds.



580-E

Mecanismo universal de doble pulsador para ahorro de agua.

Neutro (00): 20,00

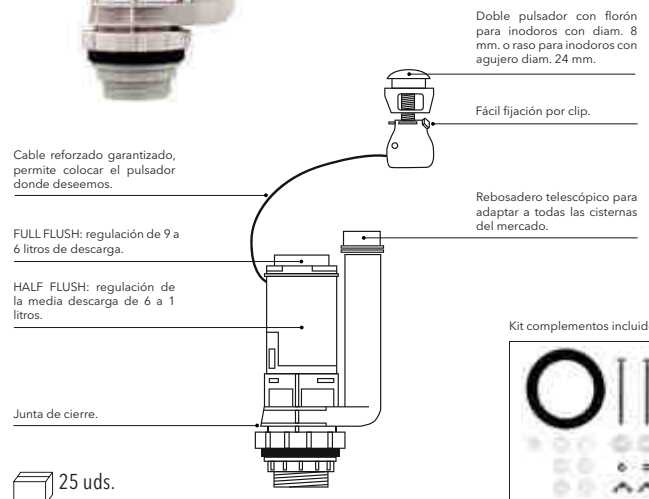

25 uds.



PRO-2108

Flotador 2 en 1 NEWS. Presión estática 16 bares y presión dinámica de 0,1 a 10 bares.

Neutro (00): 12,50

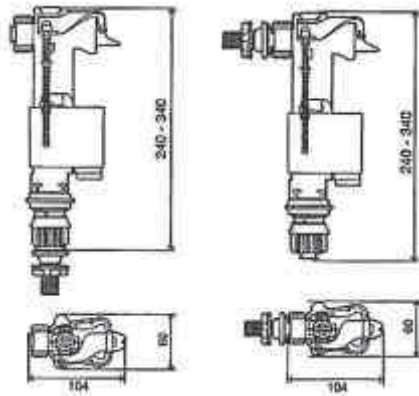

25 uds.



PRO-2003

Descarga DECO CABLE UNIVERSAL. Rosca adaptadora sistema ROCA. Descarga total 6 litros y parcial de 3 a 1 litro.

Neutro (00): 18,00

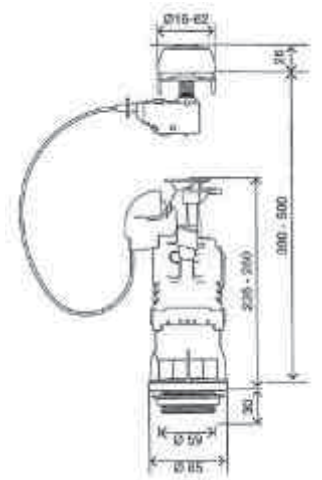

25 uds.



PRO-2002

Descarga DECO DUAL UNIVERSAL. Rosca adaptadora sistema ROCA. Descarga total 6 litros y parcial de 3 a 1 litro.

Neutro (00): 18,50

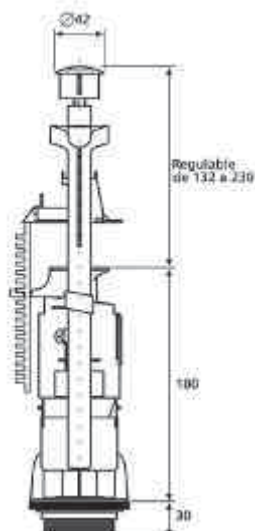

25 uds.

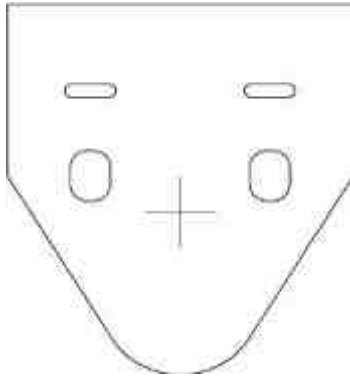

VS0805350

Protección acústica para inodoro y bidé suspendido.

Neutro (00): 16,00



VS0366133

Manguito largo 300 mm. para inodoro suspendido para salida directa a pared.

Neutro (00): 25,00

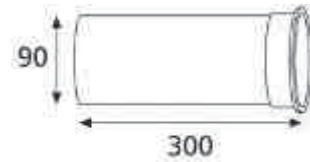

155.625.0

Manguito extensible para WC. Adaptable a cualquier salida (pared-suelo).

Neutro (00): 16,00

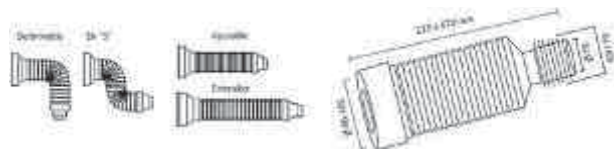

25 uds.



154.625.0

Manguito flexible para WC. Adaptable a cualquier salida (pared-suelo). Largo 540 mm.

Neutro (00): 14,00



25 uds.



154.623.0

Manguito flexible para WC. Adaptable a cualquier salida (pared-suelo). Largo 400 mm.

Neutro (00): 13,00

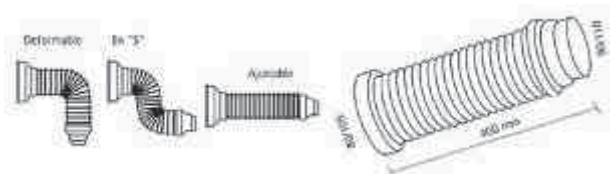

25 uds.



156.620.0

Manguito excéntrico para WC diam. 90/120.

Neutro (00): 3,00

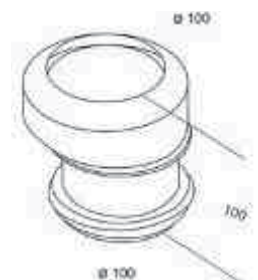

25 uds.

SILFRA





6 uds.

UD-688

Kit bidé mural con monomando integrado en soporte.

Cromo (51): 240,00

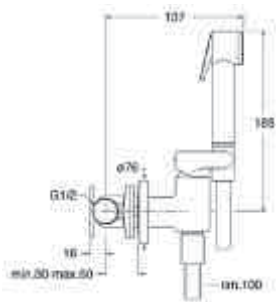

UD-690

Kit bidé monomando.

Cromo (51): 240,00

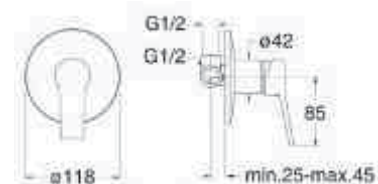

6 uds.

UD-686

Kit bidé mural con duchita con STOP.

- Cromo (51): 295,00
- Cromo negro (72): 450,00
- Oro rosa (46): 480,00
- Oro rosa satinado (34): 520,00
- Negro mate (13): 420,00
- Blanco mate (24): 420,00
- Oro (52): 495,00

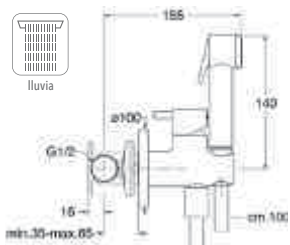

6 uds.

UD-687

Kit bidé mural RETRO con monomando integrado.

- Cromo (51): 390,00
- Bronce (92): 515,00
- Oro (52): 515,00

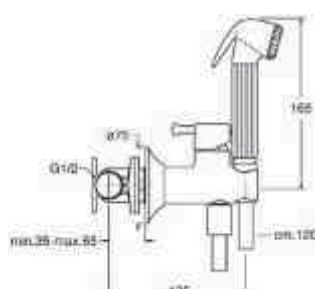

**EM-222CL**

Monomando lavabo medio con maneta gerontológica.

Cromo (51): 139,00



clinic

**EM-401CL**

Monomando ducha con maneta gerontológica.

Cromo (51): 115,00



clinic

**EM-118CL**

Monomando ducha empotrar con maneta gerontológica.

Cromo (51): 75,00



clinic

**QT-330 Batería**

Electrónico 1 agua.

Cromo (51): 393,00

**QT-338 Red**

Electrónico 1 agua.

Cromo (51): 530,00



50%

ahorro

esquema pág. 136

**QT-332 Batería**

Electrónico con regulación de temperatura.

Cromo (51): 441,00

**QT-339 Red**

Electrónico con regulación de temperatura.

Cromo (51): 580,00



50%

ahorro

esquema pág. 136

**QT-230 Batería**

Electrónico 1 agua.

Cromo (51): 571,00

**QT-238 Red**

Electrónico 1 agua.

Cromo (51): 710,00



50%

ahorro

esquema pág. 136

**QT-232 Batería**

Electrónico con regulación de temperatura.

Cromo (51): 686,00

**QT-239 Red**

Electrónico con regulación de temperatura.

Cromo (51): 825,00



50%

ahorro

esquema pág. 136

**QT-231 Batería**

Electrónico alto 1 agua.

Cromo (51): 898,00

**QT-248 Red**

Electrónico alto 1 agua.

Cromo (51): 1.041,00



50%

ahorro

esquema pág. 136

**QT-233 Batería**

Electrónico alto con regulación de temperatura.

Cromo (51): 1.053,00

**QT-243 Red**

Electrónico alto con regulación de temperatura.

Cromo (51): 1.196,00



50%

ahorro

esquema pág. 136



QT-860 Bateria
Electrónico mural 1 agua.

Cromo (51): 647,00



QT-868 Red
Electrónico mural 1 agua.

Cromo (51): 789,00



esquema pág. 136



QT-862 Bateria
Electrónico mural con regulación de temperatura.

Cromo (51): 736,00



QT-869 Red
Electrónico mural con regulación de temperatura.

Cromo (51): 879,00



esquema pág. 136



QT-820 Bateria
Electrónico urinario 1 agua.

Cromo (51): 551,00



QT-828 Red
Electrónico urinario 1 agua.

Cromo (51): 694,00



esquema pág. 136



QT-872 Bateria
Electrónico ducha con regulación de temperatura.

Cromo (51): 641,00



QT-879 Red
Electrónico ducha con regulación de temperatura.

Cromo (51): 783,00



esquema pág. 136

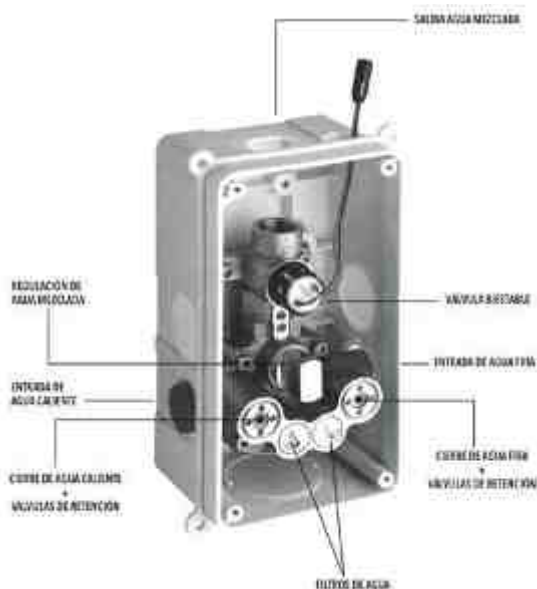

QT-230



QT-232



QT-860



Aireadores disponibles: 1,895 l/min.
3,79 l/min.
5 l/min.
6 l/min.

QT-330
QT-338
QT-332
QT-339

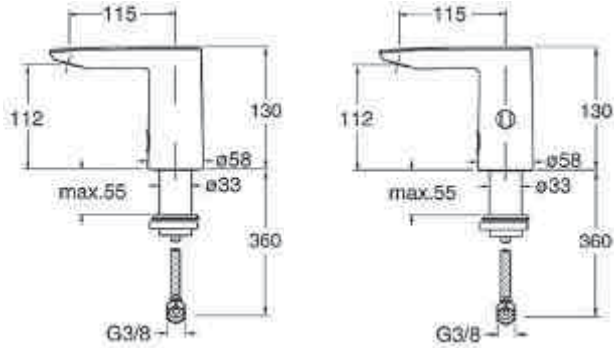

QT-230
QT-238
QT-232
QT-239

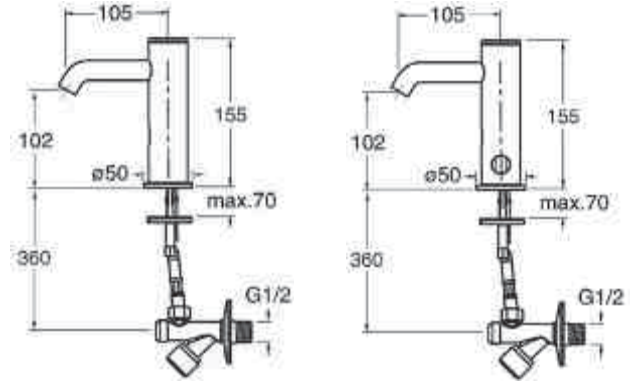

QT-231
QT-248
QT-233
QT-243

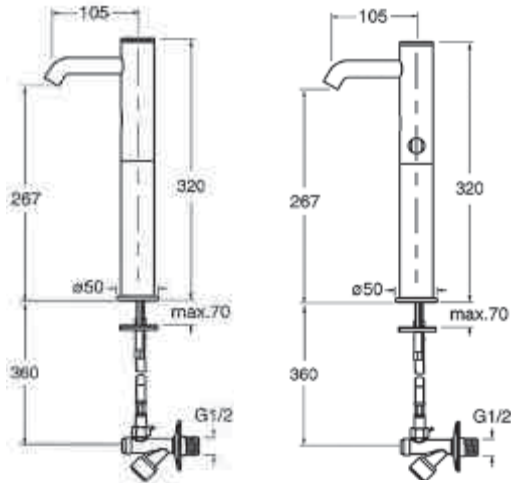

QT-860
QT-868
QT-862
QT-869

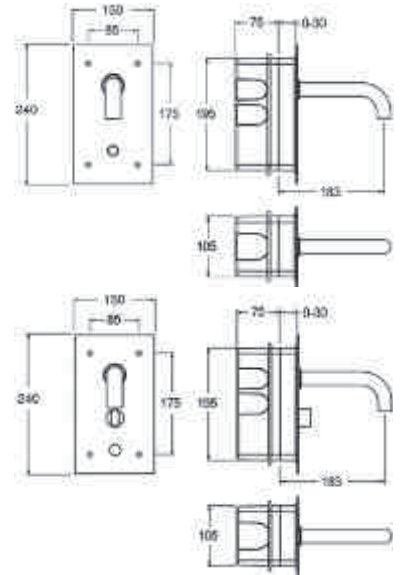

QT-820
QT-828
QT-872
QT-879

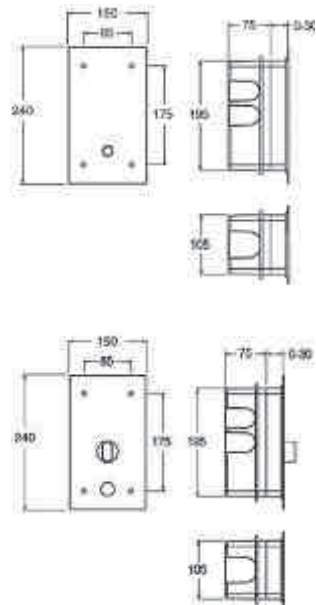



Q4-100

Temporizado urinario exterior.

Cromo (51): 69,00

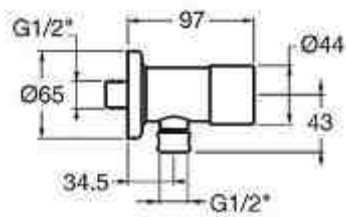

AT-979



Q4-110

Temporizado urinario empotrar.

Cromo (51): 236,00

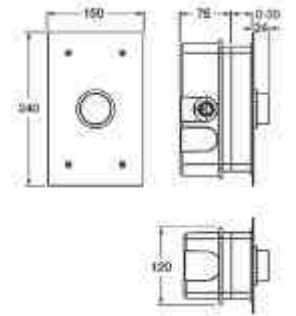

AT-981



Q4-150

Temporizado ducha empotrar.

Cromo (51): 236,00

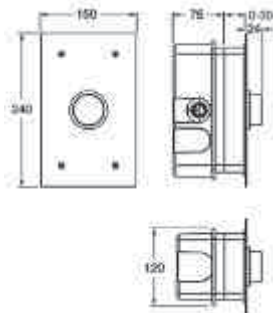

AT-980



Q4-152

Temporizado ducha con regulador de temperatura.

Cromo (51): 410,00

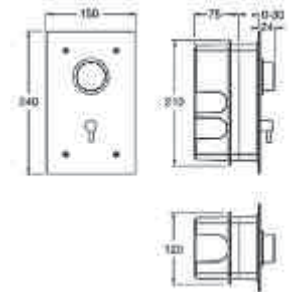

AT-980



Q4-230

Temporizado lavabo 1 agua.

Cromo (51): 145,00

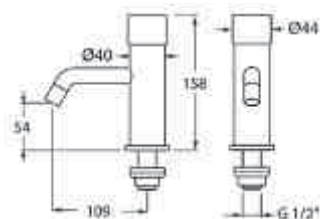

AT-976



Q4-232

Temporizado lavabo con regulador de temperatura.

Cromo (51): 167,00

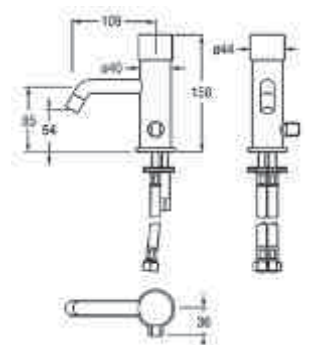

AT-976

**Q4-233**

Temporizado lavabo alto 1 agua.

Cromo (51): 267,00

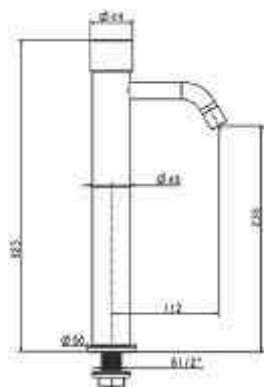

AT-976

**Q4-234**

Temporizado lavabo alto con regulador de temperatura.

Cromo (51): 314,00



AT-976

**Q4-530**

Temporizado lavabo mural 1 agua.

Cromo (51): 465,00

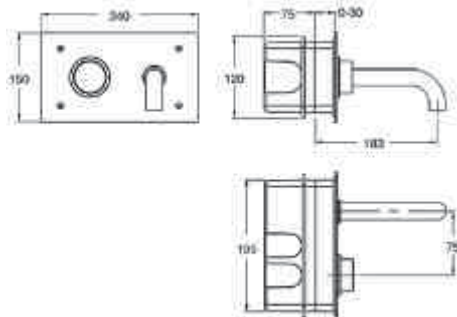

AT-976

**Q4-532**

Temporizado lavabo mural con regulador de temperatura.

Cromo (51): 602,00

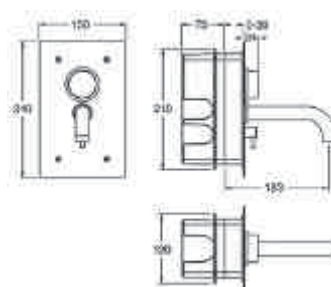

AT-976

**Q5-100**

Temporizado urinario exterior.

Cromo (51): 58,00



AT-931

**Q5-110**

Temporizado urinario empotrar.

Cromo (51): 61,00

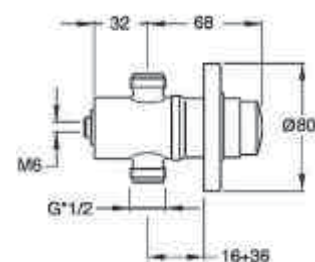

AT-971



Q5-230

Temporizado 1 agua.

Cromo (51): 69,00

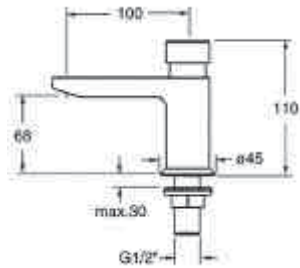

AT-936



Q5-232

Temporizado con regulador de temperatura.

Cromo (51): 108,00

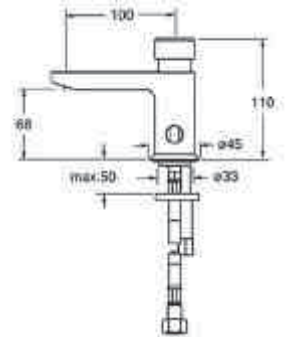

AT-936



Q5-235

Temporizado lavabo mural.

Cromo (51): 74,00

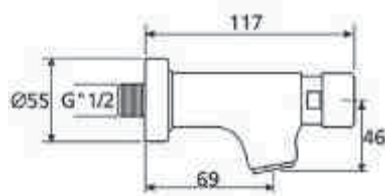

AT-936



Q5-240

Temporizado lavabo mural largo.

Cromo (51): 105,00

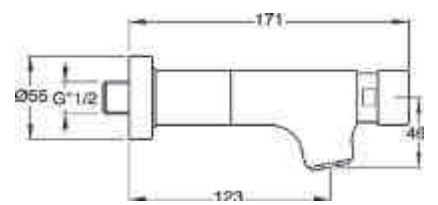

AT-936



Q5-150

Temporizado ducha.

Cromo (51): 81,00

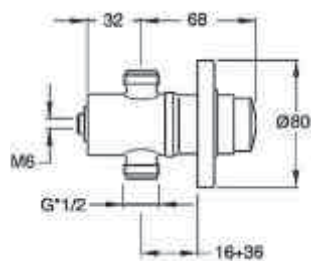

AT-905



AT-950

Pre-regulador de temperatura grifo 1 agua.

Cromo (51): 27,00

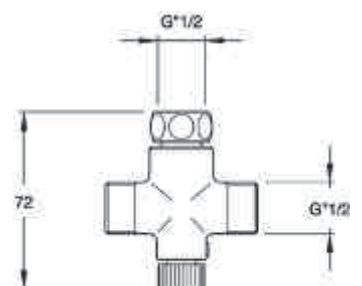

**AT-976**

Cartucho lavabo Q4, 15 segundos.

Cromo (51): 44,00

AT-979

Cartucho urinario Q4-100, 8 segundos.

Cromo (51): 40,00

AT-980

Cartucho ducha Q4, 30 segundos.

Cromo (51): 50,00

AT-981

Cartucho urinario Q4-110, 8 segundos.

Cromo (51): 50,00

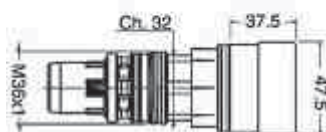
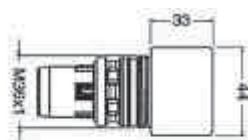
**AT-936**

Cartucho lavabo Q5, 10/20 segundos.

Cromo (51): 35,00

AT-931

Cartucho urinario Q5-100, 5-10 segundos.

Cromo (51): 35,00

AT-905

Cartucho ducha Q5-150, 20/25 segundos.

Cromo (51): 43,00

AT-971

Cartucho urinario Q5-110, 5/10 segundos.

Cromo (51): 43,00

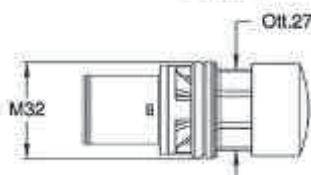
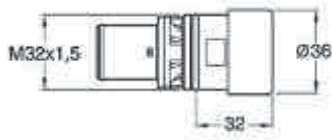
**QT-955**

Estabilizador para batería.

Cromo (51): 64,00

QT-986

Batería.

Cromo (51): 23,00

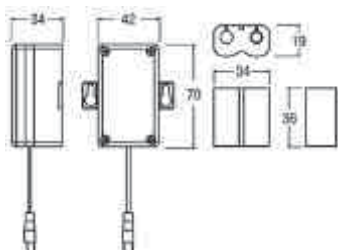
**QT-956**

Alimentador red eléctrica.

Neutro (00): 201,00

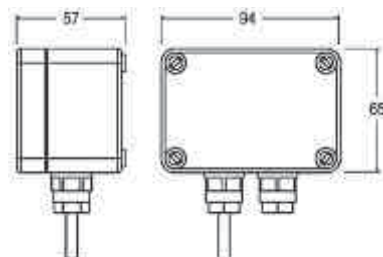
**QT-971**

Electroválvula 230, 231, 232 y 233.

Neutro (00): 48,00

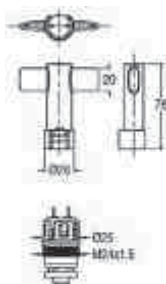
**QT-973**

Electroválvula 820, 828, 860, 862, 868, 869, 872 y 879.

Neutro (00): 48,00



Q4-530

Q4-532

**Aireadores disponibles:**

1,895 l/min.

3,79 l/min.

5 l/min.

6 l/min.



Idea ducha

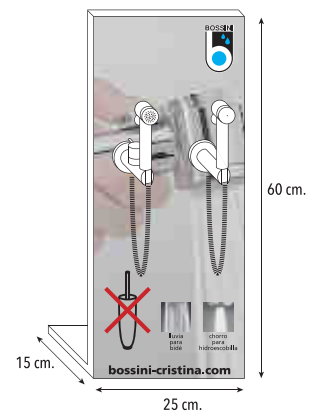
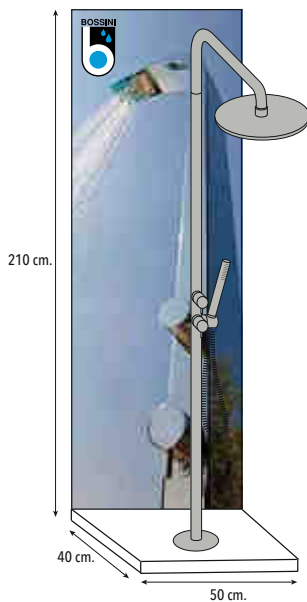
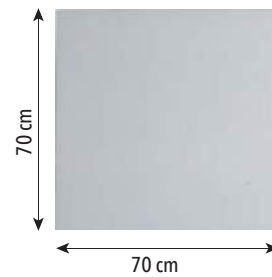
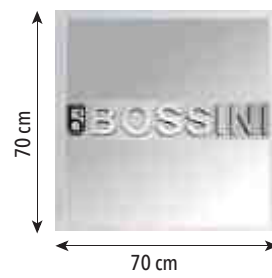

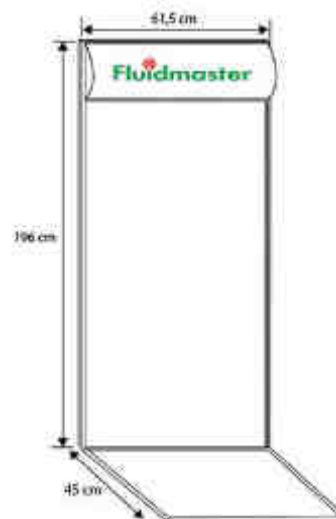
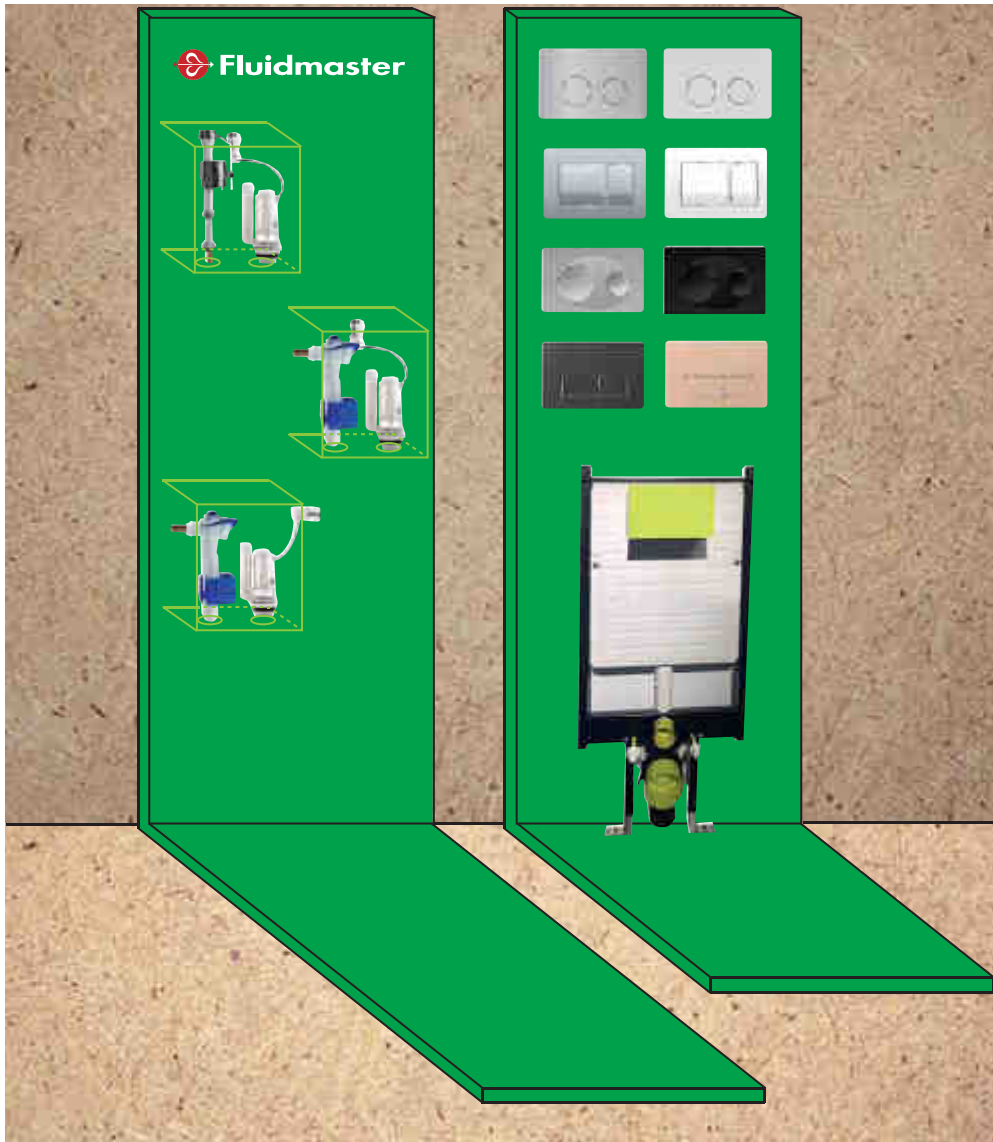



PRO-1402

Clicker universal.

Cromo (51): 16,50



30 uds.



PRO-1301

TOTI lavabo latón.

Cromo (51): 39,00



30 uds.



PRO-1403

Sustitución clicker CHAMPIÑÓN universal.

Cromo (51): 11,00



30 uds.



PRO-1303

BOTELLA lavabo latón.

Cromo (51): 16,00



60 uds.



PRO-1404

Mini clicker CHAMPIÑÓN univers al.

Cromo (51): 15,00



30 uds.



PRO-1312

CRONO en PP.

Neutro (00): 10,00



30 uds.



PRO-1603

Válvula diam. 90 mm. 3 tornillos.
Tapa ABS diam. 118 mm.
Altura reducida 62 mm.

Cromo (51): 17,00



60 uds.



PRO-1608

Válvula con tapa latón diam. 90 mm. Desagua 27 l/min.

Cromo (51): 18,00



30 uds.



PRO-1703

Desagüe bañera UP&DOWN.
UNIVERSAL con tubo corrugado
de 84 mm. Sifón salvaespacio
orientable incorporado.

Cromo (51): 42,00



15 uds.



PRO-1704

Desagüe bañera AUTOMÁTICO con
cable de 470 mm. Tubo corrugado
en PP. Sifón salvaespacio orienta-
ble incorporado.

Cromo (51): 52,00



15 uds.



PRO-1506

Reducción de goma de 32 mm.
Hx40 mm. M para tubo de salida
sifón.

Cromo (51): 4,00



30 uds.



PRO-1502

Tubo latón entrada sifón.
Diámetro 32 mm. Largo 400 mm.

Cromo (51): 7,00



30 uds.



PRO-0401
Flexible doble grapado latón
1/2"Hx1/2"H cónico.

175 cms. Cromo (51): 20,00



45 uds.



PRO-0402
Flexible CROMOLUX 1/2"Hx1/2"H
cónico CROMO BRILLO.

175 cms. Cromo (51): 12,00



45 uds.



PRO-2108
Flotador 2 en 1 NEWS. Presión es-
tática 16 bares y presión dinámica
de 0,1 a 10 bares.

Neutro (00): 12,50



25 uds.



PRO-2002
Descarga DECO DUAL UNIVERSAL.
Rosca adaptadora sistema ROCA.

Neutro (00): 18,50



25 uds.



BOSSINI es un referente a nivel mundial en la fabricación de duchas, rociadores y flexibles. Creada en 1960 por los hermanos Leonardo y Massimo Bossini, nace con la fabricación de flexibles de latón. Hoy es una realidad con 6 centros productivos en Italia con inversión continua en tecnología. Sus fábricas son completamente ecológicas, ofreciendo un producto de gran calidad con el mínimo impacto ambiental, esta inquietud, les ha llevado a adquirir recientemente el certificado ISO 14001:2004, siendo una de las pocas empresas que tienen este certificado, sólo obligatorio para el sector químico. Un moderno tren de cromado que aprovecha el agua sobrante para crear electricidad, todo ello destinado a la fabricación de duchas y rociadores con el máximo diseño y calidad.

La optimización de este empeño siempre ha puesto en primer lugar la relación con los clientes: tanto en las casas como en los hoteles, en los centros de bienestar como en los lugares públicos, las innovaciones BOSSINI representan una demostración concreta de cómo la comunicación ha asumido un papel central estratégico en la mejora de las relaciones cotidianas, contribuyendo a la obtención de resultados de excelencia.



OMP TEA es líder mundial en el sector de productos para el desagüe hidrosanitario. Nace en Lumezzane, en la provincia de Brescia a inicios de los años 50. La empresa es especialista en la producción de sifones y piletas de latón y plástico (PP, HDPE y ABS) para los sanitarios de baño y cocina. Primando sobretodo el diseño, la calidad y la funcionalidad se ha completado la gama de productos con los desagües a pavimento para duchas y zonas wellness de Hoteles, Resorts y Spas.

Gracias a las continuas inversiones, la fabricación se hace internamente con maquinaria de última generación, presas para la estampación del plástico, la automatización para el corte y pliegue del tubo de latón, islas robotizadas para el pulido de los productos en metal, máquinas automáticas para el montaje y el embalaje del producto.

Toda la producción se hace en Italia, empleando personal especializado. La experiencia de 40 años en la exportación ha permitido mejorar la calidad del producto y obtener importantes certificaciones de calidad.





SILFRA forma parte del grupo CRS, especializado en griferías electrónicas y temporizadas de alta gama, un producto técnico de gran calidad. La innovación y la búsqueda de nuevos productos que necesita el mercado es la principal razón de esta fábrica, a la que podríamos llamar una fábrica de I+D+I con la máxima calidad y como principal icono la serie QuickTronic, grifería electrónica de avanzada tecnología y diseño con las máximas prestaciones, aplicando las últimas tecnologías para mejorar la capacidad de respuesta y el ahorro de energía. Con una nueva regulación, sencilla y eficaz, permite una mayor seguridad y eficacia de la electrónica, incluso en puntos donde la electrónica estándar sufría por culpa de la sensibilidad, habitaciones muy luminosas, con espejos, brillos, ... Con ello Silfra sigue apostando por las colectividades de alta calidad y diseño con las mayores prestaciones para el ahorro de agua y energía para construcciones modernas y ecológicas.



FLUIDMASTER es la marca de flotadores número 1 en el mundo. Las piezas de Fluidmaster se encuentran en más inodoros que todas las demás marcas combinadas. Es el primer proveedor preferido y elegido por los clientes para el equipamiento de inodoros, lleva más de medio siglo diseñando ingeniosamente los mecanismos de descarga.

Construido e inspirado en una historia sin igual de innovación, Fluidmaster se ha convertido en un icono en la industria de la fontanería. El éxito comenzó con el deseo y empuje del fundador Adolf Schoepe, convencido de que la tecnología de inodoros existente era ineficiente y poco fiable, para ello quiso crear una válvula de llenado más avanzada que funcionara con la presión del agua y no contra ella. En 1957, la visión del Sr. Schoepe se convirtió en realidad cuando revolucionó la industria al lanzar la innovadora tecnología de válvulas de llenado piloto de Fluidmaster.

La popularidad de las válvulas facilitó la expansión a las líneas de productos relacionados. Hoy en día, Fluidmaster comercializa más de 100 millones de productos al año. Además de la válvula de llenado inaugural, la línea completa piezas para la reparación de inodoros que incluye válvulas de descarga, aletas, palancas de tanque, válvulas de doble descarga, cera para tazones, kits de reparación de inodoros, llaves de paso y conectores. La creciente red de distribución global de Fluidmaster llega a más del 80% de la población mundial y se extiende por más de 90 países.



WATER SAVING

Los productos BOSSINI no sólo combinan un aspecto elegante con la extraordinaria eficacia de las soluciones técnicas más modernas, sino también con la preocupación por el medio ambiente.

Porqué el agua no es un bien inagotable y es un deber de todos participar con el fin de preservar la calidad y reducir el consumo de energía.

La posibilidad de tomar medidas para reducir estos costes y tener un mayor respeto por el medio ambiente se hace fácil al implementar soluciones BOSSINI, que permiten un ahorro real, aplicable a todas las piezas con los accesorios apropiados que incorporen los reductores de caudal.



ECO FRIENDLY

NORMATIVA LEED

En Estados Unidos y en otros países alrededor del mundo, la certificación LEED es la norma reconocida para medir la sostenibilidad del edificio. Lograr la certificación LEED es la mejor manera para que usted pueda demostrar que su proyecto de construcción es verdaderamente "verde".

La certificación LEED incluye un proceso riguroso y una verificación por terceros, lo cual ofrece una prueba convincente para usted, sus clientes, sus colegas y al público en general de que el proyecto logra los objetivos ambientales.



AHORRO DE AGUA

La hoja simboliza un producto ecológico, un producto que ahorra agua y a parte está fabricado bajo las normas más estrictas, recuperando materiales y líquidos sobrantes. BOSSINI reutiliza el agua sobrante de procesos de fabricación para generar electricidad, ofreciendo productos de altas prestaciones sin dañar el medio ambiente.

Algunos de los productos BOSSINI llevan este símbolo de la hoja, para reconocer el ahorro de agua, pero todos nuestros procesos de fabricación y distribución se pueden considerar ecológicos.



AGUA LIFE

Simplemente ajustando la palanca puede elegir entre un chorro fuerte o un chorro suave y delicado, lo que reduce el consumo del agua hasta un 50%, al tiempo que garantiza el máximo confort. Indicado para particulares.



CROMOTERAPIA

Combinación de colores para un agradable y relajante baño.



VÁLVULA DE VACIADO

Sistema integrado en nuestros rociadores de BOSSINI que evitan la acumulación de agua cuando no lo utilizamos.



FÁCIL LIMPIEZA

Solamente con pasar su dedo por la salida del agua podrá limpiar griferías, rociadores y mangos.



AHORRO DE AGUA

Nuestra preocupación por el medio ambiente les acerca nuestros productos estudiados para obtener un bajo consumo.



ANTIBACTERIAS

Nuestros productos impiden la proliferación de las bacterias.



ANTICAL

Todos nuestros productos incorporan este sistema, evitando así las desagradables manchas de cal acumuladas en el baño.



VAPOR

Difrate de un baño con efecto vapor con muchos de los rociadores y mangos de nuestra serie BOSSINI.



CASCADA

Difrate de un SPA en su casa, con un relajante baño sintiendo la sensación y el placer del agua.



INOX AISI 316

Material puro y ecológico, destaca por su resistencia y durabilidad, a su vez reciclable al 100%.

PLAZO DE ENTREGA

Los plazos de entrega se entenderán siempre aproximados, no aceptando ninguna responsabilidad en el caso de demoras originadas por causas de fuerza mayor.

TRANSPORTE

La mercancía viaja siempre por cuenta y riesgo del comprador, declinando nuestra empresa toda responsabilidad en cualquier caso de pérdida, robo, etc.

El cliente debe ejercer su reclamación a la Agencia de Transporte, aunque se hayan pactado libres de portes a destino. Los pedidos de importe inferior a 150€ incluirán en la factura el 50% del coste de los portes (10€) a excepción de las Islas Canarias cuyo pedido inferior a 300€ incluirá en la factura un coste de 50€ en concepto de gastos de transportes; y en las islas de Madeira y Azores, el pedido inferior a 300€ incluirá en la factura un cargo de 50€.

GARANTÍA

Garantizamos todos nuestros artículos contra cualquier defecto de fabricación, no responsabilizándonos de posibles daños causados a terceros.

No se podrán poner demandas ni efectuar ningún tipo de acción legal hasta después de haber efectuado el pago de la totalidad del envío del material.

SUMINISTROS

La empresa procurará suministrar los pedidos completos. En caso de suministros parciales se facturará la mercancía suministrada.

La mercancía será de nuestra propiedad hasta que no se haya efectuado el pago en su totalidad.

Nos reservamos el derecho de suministrar mercancías en el caso de que esté pendiente algún pago.

PEDIDOS Y DEVOLUCIONES

Los pedidos son en firme y no se aceptará ninguna devolución que no haya sido acordada con la empresa, recibiendo siempre autorización escrita y específica del material acordado a devolver.

Solamente se administran aquellas devoluciones de artículos que estén en perfecto estado y que figuren en el catálogo al tiempo de producirse la devolución.

Todas las devoluciones sufrirán una depreciación de un 15% en concepto de revisión de material, embalajes, administración, etc.

Cargo portes 10€ recogida.

No se admitirán reclamaciones transcurridos 10 días después de la recepción del material.

PRECIO, FORMA Y CONDICIONES DE PAGO

60 días fecha factura y/o con días de pago: con recibo domiciliado en el banco.

21 días fecha factura con descuento del 2% por pronto pago: con recibo domiciliado en banco exclusivamente.

Sólo se considera que existe la opción de venta a crédito cuando exista la autorización de nuestra compañía aseguradora.

Los precios válidos son los que obren en la tarifa del catálogo al momento de cursar el pedido.

A los precios indicados deberá sumarse el impuesto sobre el valor añadido vigente al tiempo de celebración de compraventa.

El cliente renuncia a su propio fuero, si lo tuviese, y se someterá a efectos de interpelación, cumplimiento y ejecución del presente contrato de compra y venta, a la jurisdicción de los Tribunales de Justicia de Barcelona.



Índice por productos

REFERENCIA	PÁGINA	REFERENCIA	PÁGINA	REFERENCIA	PÁGINA	REFERENCIA	PÁGINA	REFERENCIA	PÁGINA
010043	37	471.121.8	117	910177	36	B00092	46	CD4000	76
010800	37	471.131.8	117	910255	36	B00152	44	CD5000	76
010805	37	471.141.8	117	910270	36	B00160	45	D01000	47
030580	33	471.181.8	117	916.324.5	87	B00161	45	D03000	48
030586	33	485.309.5	96	919.639.6	87	B00162	45	D07000	49
030750	33	485.903.5	89	943.904.8C	112	B00167	45	D37021	15
070075	40	485.903.6	89	943.906.8C	112	B00168	43	D40000	48
070805	40	514.135.5	86	963.111.8	114	B00169	43	D41000	48
101.175.60	98	519.225.5	88	963.121.8	114	B00177	43	D72000	49
102.165.6	98	5261.076.6	100	963.131.8	114	B00250	46	D74000	47
102.480.5	98	5261.086.6	100	963.141.8	114	B00252	46	D91000	47
114.001.5	98	530.300.5	91	970.101.8	111	B00255	46	DA5000	47
115.310.5	98	530.320.5	91	971.101.8	113	B00260	46	DD1000	48
115.350.5	98	530.329.5	90	971.121.8	113	B00270	46	DD10800	32
115.870.5K	98	530.360.5	91	971.131.8	113	B00442	60	DD10805	32
12.480.6	98	530.750.5	90	971.141.8	113	B00444	59	DE6000	15
133.435.6	96	530.960.5	91	971.831.8	115	B00470	60	DE6000	49
133.535.6	96	540.300.5	92	973.201.8	111	B00475	60	DE6160	42
137.040.0	95	540.320.5	92	979.600.5	119	B00580	44	DE6168	42
137.050.5	96	540.360.5	92	979.800.0	119	B00586	44	DE6169	42
147.555.5	95	540.750.5	90	979.811.0	119	B00650	60	DE6800	42
147.955.5	95	540.960.5	92	979.850.5	119	B00653	60	DE6805	42
150.533.5	98	542.742.5	95	979.X42.0	119	B00661	60	E37018	56
154.623.0	129	555.096.5	95	983.401.8	110	B00750	44	E57006	57
154.625.0	129	575.131.8	118	9999.0405	92	B00800	43	E59000	80
155.625.0	129	575.631.8	118	A00048	52	B00802	43	E60500	80
156.620.0	129	580-E	127	A00158A	53	B00805	43	E61500	80
159.250.5	98	62.405.5	105	A00158D	53	C03000	77	E78000	83
177.100.0	119	62.450.6	105	A00170	53	C04000	77	E86903	83
19.225.5	87	62.455.5	105	A02035	52	C04042	58	E86905	83
19.235.5	87	6241.076.6	100	A02053	53	C04043	58	E86906	83
1910.111.5	89	6261.076.6	100	A03045	52	C04044	58	E86908	73
1912.211.5	89	6461.066.6	100	A04045	52	C04045	57	E86911	73
1950.511.5	89	65.409.6	105	A04047	53	C04047	56	E88500	83
1950.708.5	89	6561.106.6	100	A100170	53	C04048	56	E88600	83
1952.708.5	89	6561.286.6	100	A102035	52	C04050	56	EM-118CL	133
245.096.6	101	661.096.6	101	A104045	52	C10001	82	EM-222CL	133
247.304.0	97	700.135.5	86	A500160	39	C12000	78	EM-401CL	133
2562.521.8	105	710.135.5	86	A500168	39	C12152	51	F2-0053	122
2565.521.8	105	711.135.5	87	A500169	39	C12169	50	H19000	21
26.925.5	88	713.135.5	88	A500802	39	C12250	50	H19166	28
261.086.6	101	720160	41	ACOM 65	107	C17000	76	H19169	28
263.241.8	118	720167	41	AD-200	102	C30092	51	H19405	27
265.241.8	118	720802	41	AD-400	102	C30169	50	H19410	27
2665.491.8	115	731.401.8	111	AD-420	102	C30250	50	H19420	27
271.111.8	116	740168	38	AD-600	102	C30805	51	H19625	25
271.121.8	116	740169	38	AD-880	102	C50000	77	H19701	28
271.131.8	116	740805	38	AL-2000	106	C51000	76	H19703	28
271.141.8	116	747-E	127	AL-2000R	106	C54000	76	H27740	28
271.181.8	116	7530.750.5	90	AL-VERMAG	106	C54169	50	H28000	22
2755.405.8	115	77.100.0	119	AS-050	106	C54250	50	H31000	22
2930.300.5	97	78.250.5	88	AS-073	106	C54255	51	H31169	23
34.170.5	95	78.300.5	88	AS-078	106	C54805	51	H31405	23
34.620.5	95	78.400.5	88	AS-266S	104	C55001	57	H31420	23
347.607.0	97	80.150.5	88	AS-370S	104	C55255	51	H31595	23
390.223.5	88	80.400.5	88	AT-905	140	C67003	57	H31596	23
400250	34	800.136.5	86	AT-931	140	C67004	59	H31597	24
400255	34	8034.322.5	90	AT-936	140	C69001	57	H31598	24
400260	34	810.136.5	86	AT-950	139	C69002	59	H31620	23
400-E	127	811.136.5	87	AT-971	140	C89001	57	H31625	24
40252	34	8120.380.5	91	AT-976	140	C89002	59	H35360	11
407-E	127	8120.387.5	90	AT-979	140	C95000	77	H35362	11
410169	35	8120.480.5	91	AT-980	140	C98014	58	H35363	11
410173	35	8120.487.5	90	AT-981	140	C98015	59	H35365	12
410250	35	813.343.5	96	B00043	44	CA3000	77	H35366	11
461.096.6	101	813.353.5	96	B00067	45	CA3001	58	H35367	11
47.100.0	98	8532.310.5	92	B00069	45	CB7000	77	H35369	12
471.111.8	117	871.142.0	119	B00075	44	CD2000	76	H35370	12

REFERENCIA	PÁGINA	REFERENCIA	PÁGINA	REFERENCIA	PÁGINA	REFERENCIA	PÁGINA	REFERENCIA	PÁGINA
H37395	9	I00151	74	M00600	61	Q5-100	138	V00228	78
H37397	9	I00153	75	M00602	62	Q5-110	138	V00240	78
H37398	9	I00166	19	M00604	63	Q5-150	139	VS0366133	129
H37450	7	I00169	19	M00606	61	Q5-230	139	VS0805350	129
H37451	8	I00171	17	M00608	62	Q5-232	139	WA-034S	94
H37452	8	I00175	73	M00610	63	Q5-235	139	WA-334	93
H37453	9	I00176	73	M00616	64	Q5-240	139	WA-335	93
H37454	9	I00197	73	M00618	64	QT-230	134	WA-431S	94
H37455	7	I00198	73	MOD-06122	103	QT-231	134	Z00539	56
H37456	7	I00214	75	MOD-06222/51	103	QT-232	134		
H37457	7	I00271C	18	MOD-06322/51	103	QT-233	134		
H38380	13	I00271F	18	MOD-06422/51	103	QT-238	134		
H38381	12	I00330	20	MOD-06522/51	103	QT-239	134		
H38387	12	I00351	19	MOD-06622/51	103	QT-243	134		
H38458	13	I00352	20	MOD-D6261	103	QT-248	134		
H38459	12	I00405	17	MOD-U2A11	103	QT-330	134		
H38661	8	I00410	17	MOD-U3I	104	QT-332	134		
H38905	7	I00420	17	MOD-V1A85	103	QT-338	134		
H38906	7	I00570	13	MOD-V1U29	103	QT-339	134		
H38907	6	I00571	13	P40-0110	123	QT-820	135		
H38908	6	I00575	13	P40-0190	123	QT-828	135		
H38909	6	I00576	13	P43-0120	123	QT-860	135		
H38933	10	I00590	6	P43-0130	123	QT-862	135		
H38925	10	I00591	6	P57-0018	123	QT-868	135		
H38927	10	I00592	6	P57-0110	123	QT-869	135		
H38928	10	I00595	16	P57-0120	123	QT-872	135		
H38929	10	I00596	16	P57-0130	123	QT-879	135		
H41000	22	I00597	16	P58-0018	124	QT-955	140		
H41010	29	I00598	16	P58-0120	124	QT-956	140		
H41020	29	I00620	16	P58-0130	124	QT-971	140		
H41330	29	I00625	16	P58-0180	124	QT-973	140		
H41351	29	I00701	18	P58-0181	124	QT-986	140		
H41352	29	I00703	18	P58-0182	124	R00002	79		
H55000	21	I00715	17	P58-0183	124	R00005	79		
H55405	28	I00717	10	P58-0184	124	R00007	79		
H60000	21	I00718	11	P58-0185	124	R00009	79		
H60715	26	I00720	17	P58-0190	124	R00011	79		
H60720	26	I00723	9	PD-467	82	R00012	79		
H61000	21	I00724	8	PP-130	93	RI-005	107		
H61171	24	I01723	8	PRO-0401	146	RI-038	107		
H61715	24	I01724	8	PRO-0402	146	RI-085	107		
H61720	24	INL001	70	PRO-1301	144	TO5-0130	122		
H69000	21	L000510	81	PRO-1303	144	TO5-2116	122		
H69597	25	L000511	81	PRO-1312	144	TO6-5113	122		
H69598	25	L000512	81	PRO-1402	144	UD-152	94		
H70000	21	L000530	81	PRO-1403	144	UD-155	94		
H70405	27	L000531	81	PRO-1404	144	UD-325S	94		
H70405 ABS	25	L000532	81	PRO-1502	145	UD-370S	102		
H70410	27	L00055	81	PRO-1506	145	UD-389S	93		
H70595	25	L00085	80	PRO-1603	145	UD-425S	93		
H70596	25	L00273	80	PRO-1608	145	UD-531	94		
H70715	26	L00356	70	PRO-1703	145	UD-686	132		
H70720	27	L00359	69	PRO-1704	145	UD-687	132		
H75362	26	L00361	69	PRO-2002	128	UD-688	132		
H75365	26	L00362	68	PRO-2002	146	UD-690	132		
H75366	26	L00814	71	PRO-2003	128	UD-830	93		
H89405C	14	L00815	68	PRO-2108	128	V00001	78		
H93410G	14	L00818	69	PRO-2108	146	V00011	78		
I00010	19	L00822	71	Q4-100	137	V00014	78		
I00020	19	L00824	69	Q4-110	137	V00064	82		
I00065	19	L00831	72	Q4-150	137	V00070	82		
I00090	18	L00846	72	Q4-152	137	V00099	82		
I00096	18	L00860	68	Q4-230	137	V00105	81		
I00102	74	L00861	68	Q4-232	137	V00106	81		
I00136	74	L00862	71	Q4-233	138	V00115	82		
I00138	74	L00863	71	Q4-234	138	V00116	81		
I00142	74	L60001	14	Q4-530	138	V00160	80		
I00148	74	L60002	14	Q4-532	138	V00180	80		

